

# ACQUADOLCE

**ACQUADOLCE**  
design F. Sargiani

04 ACQUADOLCE DREAM

18 ACQUADOLCE LIGHT

28 ACQUADOLCE

“La doccia domestica è un oggetto che deve dare grande comfort e piacere a chi lo usa. Il contatto con l’acqua deve essere un’esperienza felice, un ritorno allo stato naturale”.  
[ Franco Sargiani ]

Acquadolce è una collezione di docce multifunzionali che offrono il massimo comfort multisensoriale e ambientale: acqua a pioggia, a cascata o nebulizzata, luce bianca, cromoterapia con luce a quattro colori, programma “Feel” per creare un’atmosfera emozionale, tecnologia touch per i comandi a sfioramento che attivano le diverse funzioni. L’ estrema essenzialità formale e costruttiva e le prestazioni innovative di Acquadolce sono l’esito della continua ricerca progettuale e tecnica condotta dall’azienda e dall’affinamento del suo know how produttivo.

“Ho giocato su dei componenti elementari: un quadrato, un rettangolo. Piani e linee che si compongono in molteplici forme e danno un senso di estrema leggerezza, che per me è un valore determinante del progetto”.  
[ Franco Sargiani ]

“The shower is a household fitting must offer a great comfort and pleasure to its user. The contact with water should be a joyful experience, a sort of return to a natural state”.  
[Franco Sargiani]

Acquadolce is a collection of multi-functional showers that offer the highest multi-sensory and space comfort: rain, waterfall or mist, white light, cromotherapy with 4-colour light, “Feel” programme to create a multi-sensory atmosphere, touch-screen technology to activate the different functions. The extremely essential shape and construction of Acquadolce together with its innovative performance are the result of the company’s relentless research into design and technique as well as their improvements in manufacturing expertise.

“I played with some elementary components: a square and a rectangular. Planes and lines combining into multiple shapes, yet giving a sense of extreme lightness, which for me represents a fundamental asset of this project”.  
[ Franco Sargiani ]

“La douche domestique est un objet qui doit donner grand confort et plaisir à qui l’utilise. Le contact avec l’eau doit être une expérience heureuse, un retour à l’état naturel!”.  
[ Franco Sargiani ]

Acquadolce est une collection de douches multifonctions qui offrent le maximum du confort sensoriel et environnementale: eau sous forme de pluie, en cascade ou pulvérisée, lumière blanche et lumière chromothérapie avec quatre couleurs, programme “Feel” pour créer une ambiance séduisante, technologie touch par des boutons tactiles qui déclenchent les différentes fonctions. La forme purement essentielle et constructive ainsi que les performances innovantes de Acquadolce sont le résultat de la recherche continue en termes de design et technique que l’Entreprise conduit pour le développement de son know how productif.

“J’ai joué avec des éléments simples: un carré, un rectangle. Plans et lignes qui se disposent en formes variées et donnent un sens très léger, qui pour moi, est un plus à ce projet”.  
[ Franco Sargiani ]

“Die Dusche als Bestandteil des Hausstands muss großen Komfort und Vergnügen für den Benutzer bieten. Der Kontakt mit Wasser sollte eine freudvolle Erfahrung sein, eine Art Rückkehr zum Naturzustand.”  
[ Franco Sargiani ]

Acquadolce ist eine Kollektion von multifunktionalen Duschen, die höchsten Komfort durch vielfache Funktionen für alle Sinne bieten: Regen, Wasserfall oder Vernebler, Weißlicht, Farblicht; “Feel“-Programm für eine Atmosphäre, die alle Sinne anspricht; Sensortechnologie, um die verschiedenen Funktionen zu aktivieren. Die extrem essentielle Form und Konstruktion von Acquadolce, zusammen mit ihrer innovativen Leistung sind das Ergebnis von Fantini’s unermüdlicher Forschung in Design und Technik, sowie des Fortschritts bei Produktionsverfahren.

“Ich spielte mit ein paar elementaren Komponenten: einem Quadrat und einem Rechteck. Flächen und Linien in vielfache Umriss zu kombinieren und ihnen dadurch den Anschein extremer Leichtigkeit zu verleihen, repräsentiert für mich die fundamentale Stärke dieses Projekts.”  
[ Franco Sargiani ]

“La ducha de casa es un objeto que debe dar gran confort y placer al usuario. El contacto con el agua debe ser una experiencia feliz, un retorno al estado natural”.  
[ Franco Sargiani ]

Acquadolce es una colección de duchas multisensoriales que ofrecen el máximo confort multisensorial y ambiental : lluvia, cascada o nebulización, luz blanca, cromoterapia con luz en cuatro colores, programa “Feel” para crear una atmosfera emocional, tecnología touch para los controles con teclas táctiles que activan las diferentes funciones. La simplicidad formal y constructiva extrema y las prestaciones innovativas de Acquadolce son el resultado de la planificación continua y la investigación técnica llevada a cabo por la empresa y por el perfeccionamiento de su know how productivo.

“He jugado con los componentes elementales : un cuadrado, un rectángulo. Planos y líneas que se componen en muchas formas y dan una sensación de ligereza, que para mí es un valor determinante del proyecto”.  
[ Franco Sargiani ]

Acquadolce Dream: pioggia, cascata, nebulizzazione, luce bianca, cromoterapia con luce a quattro colori (rosso, blu, giallo, verde) programma "Feel" per creare un'atmosfera emozionale. Tecnologia touch per i comandi che attivano le diverse funzioni, con una gestualità che risponde all'attuale sensibilità degli utenti. Versione da soffitto con luce perimetrale e con luce bianca o da soffitto esterno con effetto di luce ambientale, in acciaio lucido e spazzolato. Idoneo anche per installazioni in bagno turco.

Acquadolce Dream: rain, waterfall, mist, white light, cromotherapy with 4-colour light (red, blue, yellow, green), and the "Feel" programme to create a multi-sensory atmosphere. Touch-screen technology to activate the different functions with user-friendly gestures. In-wall ceiling-mount model with perimeter lights and white light or ceiling-mount with ambient light effects, both in polished or brushed stainless steel. Suitable for installation in steam rooms.

Acquadolce Dream: pluie, cascade, brumisateur, lumière blanche, chromothérapie avec lumière en 4 couleurs (rouge, bleu, jaune, vert) programme "Feel", pour créer une ambiance séduisante. Technologie touch pour les boutons tactiles qui déclenchent les différentes fonctions avec des gestes familiales. Version plafond encastrée avec lumière périmétrique chromothérapie et lumière blanche ou version plafond externe avec effet éclairage, en acier inoxydable brillant et brossé. Adapté à l'installation dans hammam.

Acquadolce Dream: Regen, Wasserfall, Vernebler, Weißlicht, Farblicht (rot, blau, gelb, grün), "Feel"-Programm für eine Atmosphäre, die alle Sinne anspricht. Sensortechnologie, um die verschiedenen Funktionen benutzerfreundlich zu aktivieren. Decken-Einbau-Modell mit umlaufender Beleuchtung und Weißlicht oder Decken-Aufbau-Modell mit Umgebungslicht-Effekt – beide Versionen in poliertem oder gebürstetem Edelstahl. Geeignet auch für Installation in Dampfbädern.

Acquadolce Dream: lluvia, cascada, nebulización, luz blanca, cromoterapia con luz en cuatro colores (rojo, azul, amarillo, verde), programa "Feel" para crear una atmosfera emocional. Tecnología touch para los controles que activan las diferentes funciones, con una gestualidad que responde a la sensibilidad actual de los usuarios. Versión de techo con luz perimetral y con luz blanca o de techo exterior con efecto de luz ambiente, en acero brillante o cepillado. También indicado para instalación en hammam.

 **IMQ**  
pending



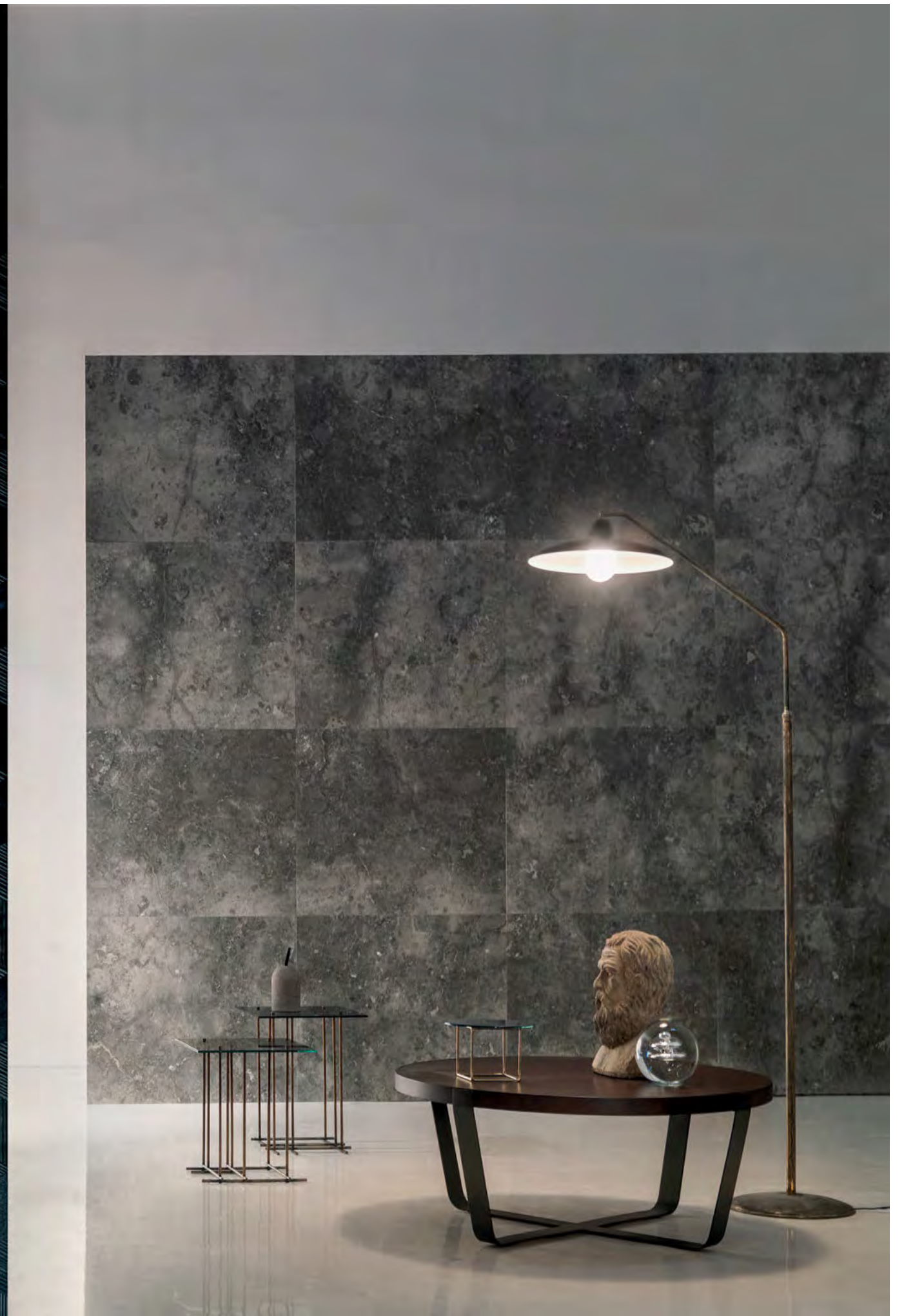



#### ART. L051

Soffione da soffitto con funzioni pioggia, cascata, nebulizzazione, luce bianca, cromoterapia (giallo, rosso, verde, blu) e programma "Feel".

Ceiling shower head, rainfall, waterfall and mist function, white led lights, chromotherapy (yellow, red, green, blue) and "Feel" program.

Pomme de douche de plafond avec fonctions pluie, cascade, brumisateur lumière blanche, chromothérapie (jaune, rouge, vert, bleu) et programme "Feel".

Deckenkopfbrause mit Regen, Wasserfall, Vernebler, Weiss Licht, Farblicht-Therapie (gelb, rot, grün, blau) und Programm "Feel".

Rociador de techo con función lluvia, cascada, nebulizador, luz blanca, cromoterapia (amarillo, rojo, verde, azul) y programa "Feel".

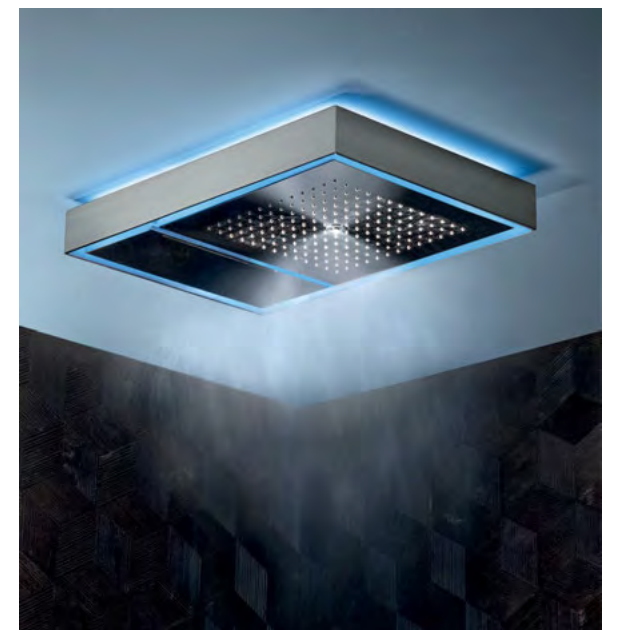
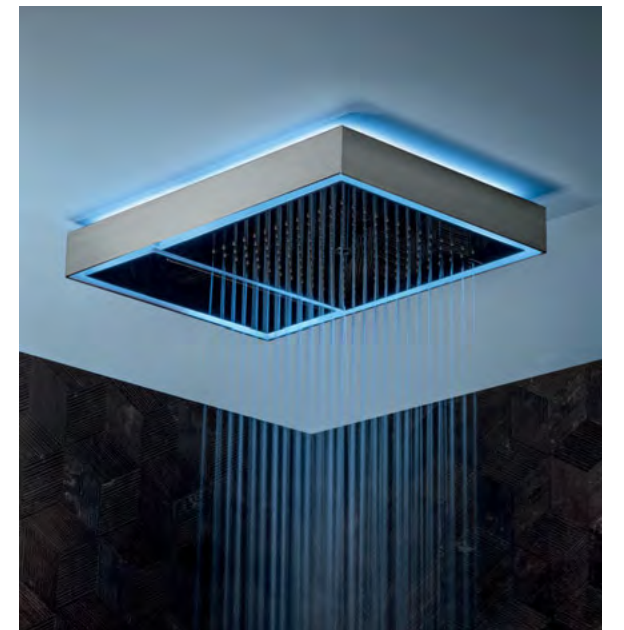
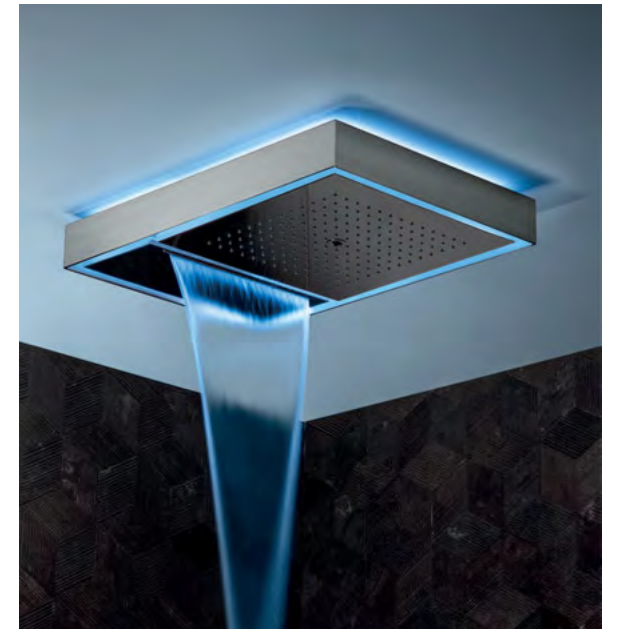

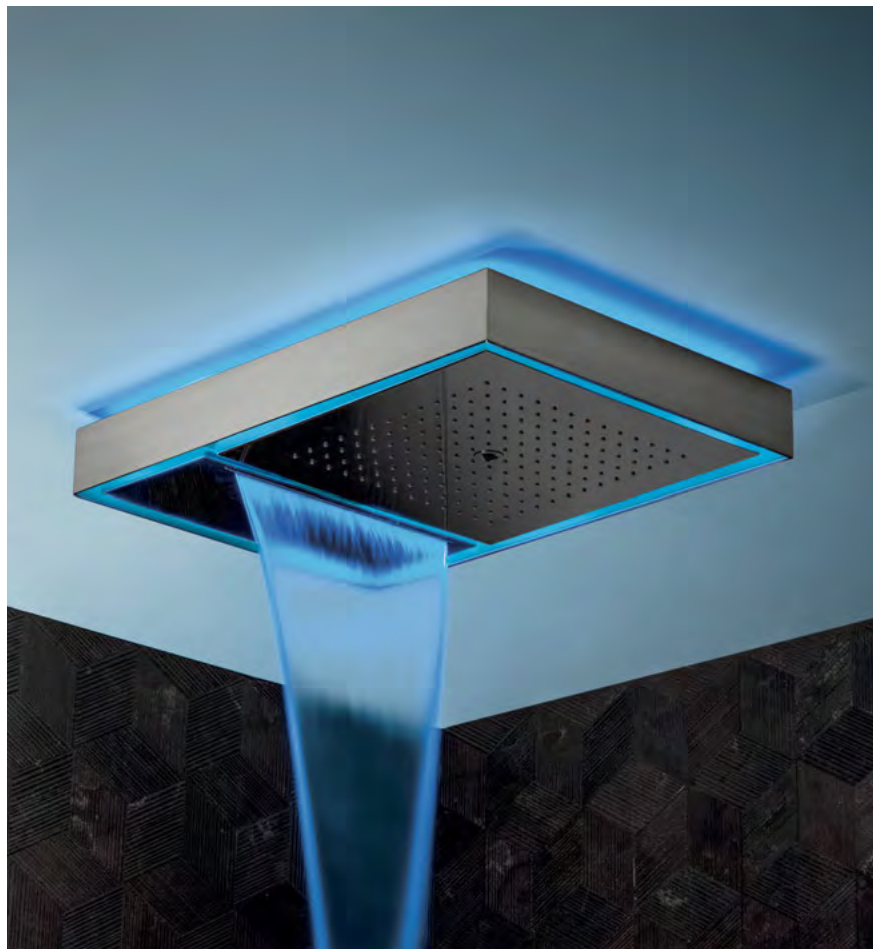
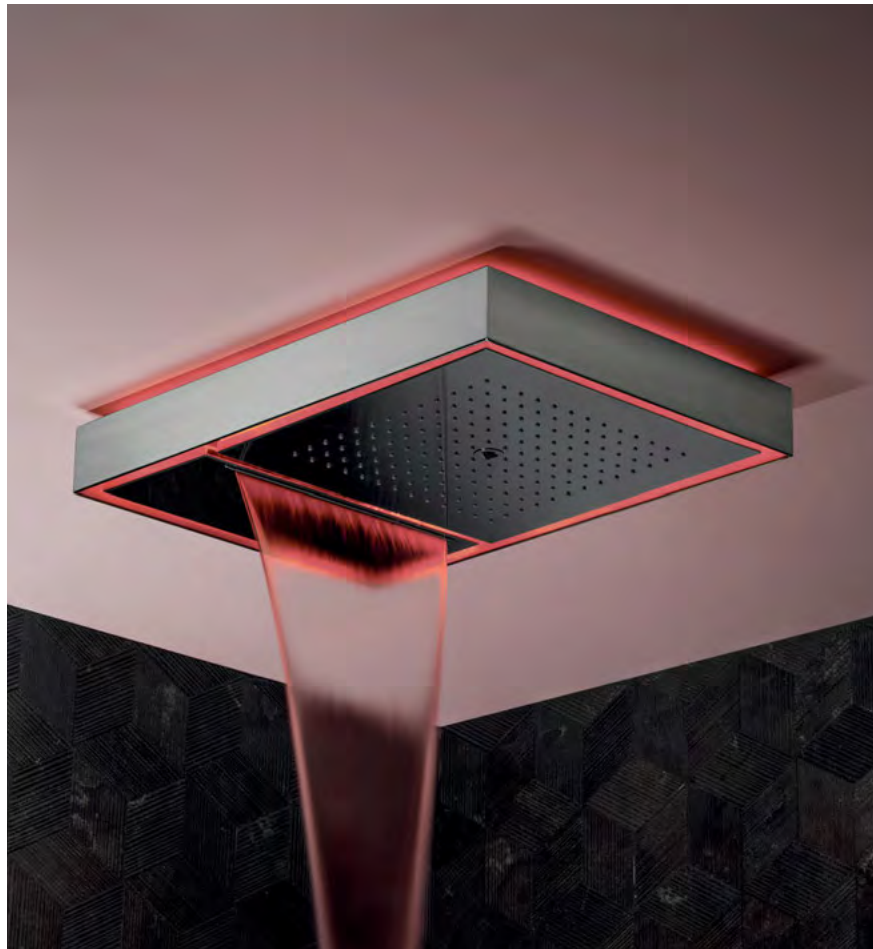

#### ART. L051

Soffione da soffitto con funzioni pioggia, cascata, nebulizzazione, luce bianca, cromoterapia (giallo, rosso, verde, blu) e programma "Feel".

Ceiling shower head, rainfall, waterfall and mist function, white led lights, chromotherapy (yellow, red, green, blue) and "Feel" program.

Pomme de douche plafond avec fonctions pluie, cascade, brumisateur lumière blanche, chromothérapie (jaune, rouge, vert, bleu) et programme "Feel".

Deckenkopfbrause mit Regen, Wasserfall, Vernebler, Weiss Licht, Farblicht-Therapie (gelb, rot, grün, blau) und Programm "Feel".

Rociador de techo con función lluvia, cascada, nebulizador, luz blanca, cromoterapia (amarillo, rojo, verde, azul) y programa "Feel".

Acqua, colori e luci per migliorare il proprio senso di benessere. La cromoterapia con i classici colori rosso, blu, verde e giallo si attiva premendo il pulsante COLOR della tastiera di controllo touch.

Water, colours and lights to improve your sense of wellbeing. The chromotherapy with the classic red, blue, green and yellow colours is activated by pushing the COLOR button on the IC-board.

Eau, couleurs et lumière pour améliorer son propre sens du bien être. La chromothérapie avec les couleurs classiques rouge, bleu, vert et jaune, se déclenche en appuyant sur la touche COLOR du clavier de contrôle touch.

Wasser, Farben und Licht sorgen für ein gesteigertes Wohlbefinden. Die Farblichttherapie mit den klassischen Farben rot, blau, grün und gelb wird durch die Betätigung der entsprechenden Taste COLOR an der Bedienblende aktiviert.

Agua, colores y luces para mejorar nuestra sensación de bienestar. La cromoterapia con los colores clásicos rojo, azul, verde y amarillo se acciona presionando el pulsador COLOR del panel de control touch.

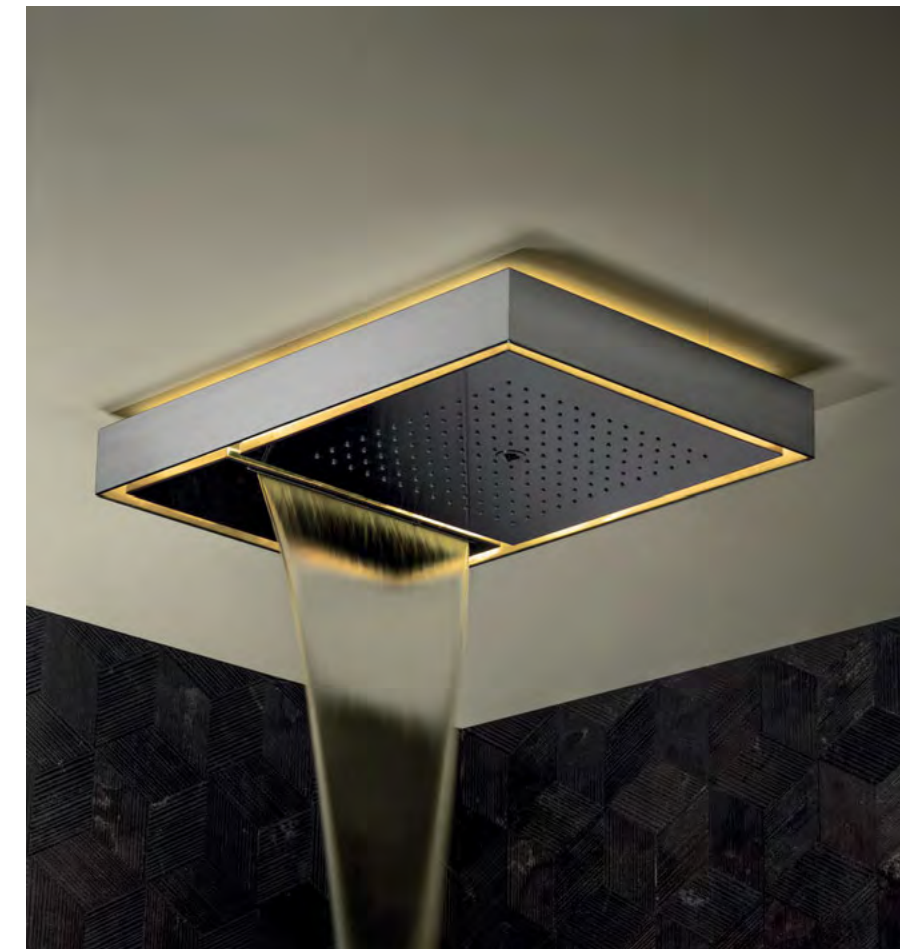
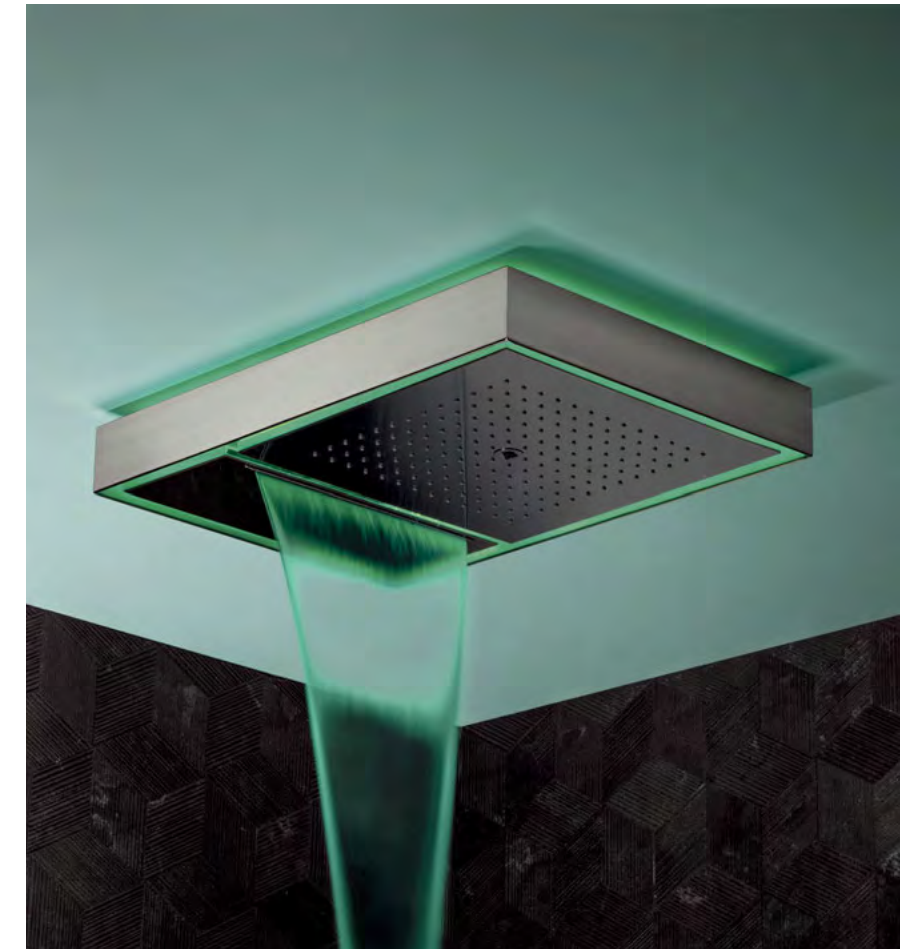









**ART. L041 - D231A/7331B -  
L101A/L101B - 8091A/8091B**

Soffione da soffitto con funzioni pioggia, cascata, nebulizzazione, luce bianca, cromoterapia (giallo, rosso, verde, blu) e programma "Feel". Miscelatore termostatico incasso 3/4" 1 uscita. Tastiera di controllo touch per attivazione funzioni. Completo doccia con on/off automatico.

Ceiling shower head, rainfall, waterfall and mist function, white led lights, chromotherapy (yellow, red, green, blue) and "Feel" program. 3/4" built-in thermostatic mixer 1 outlet. Functions control board. Shower set with automatic on/off.

Pomme de douche plafond avec fonctions pluie, cascade, brumisateur lumière blanche, chromothérapie (jaune, rouge, vert, bleu) et programme "Feel". Mitigeur thermostatique à encastrer 3/4" 1 sortie.

Clavier de contrôle pour mise en fonctions des différents activités. Combiné de douche avec on/off automatique.

Deckenkopfbrause mit Regen, Wasserfall, Vernebler, Weiss Licht, Farblicht-Therapie (gelb, rot, grün, blau) und Programm "Feel". UP-Thermostatmischer 3/4" 1 Ausgang Touch-Steuerung um Funktionen zu aktivieren. Brauseset mit Automatik on/off.

Rociador de techo con función lluvia, cascada, nebulizador, luz blanca, cromoterapia (amarillo, rojo, verde, azul) y programa "Feel". Monomando termostático empotrado 3/4" 1 salida. Pulsadores de control touch para activar funciones. Conjunto de ducha con on/off automático.



Acquadolce Light: versione con braccio a parete con funzioni pioggia, cascata, nebulizzatore con luce bianca sullo stesso piano (monoplano) o su due diversi piani sfalsati (biplano), in acciaio lucido e spazzolato. Idoneo anche per installazioni in bagno turco.

Acquadolce Light: model with wall-mount arm and rain, waterfall and mist functions plus white light on the same panel (one module) or on two different staggered panels (two modules). Suitable for installation in steam rooms.

Acquadolce Light: version murale avec bras, avec fonctions pluie, cascade, brumisateur, lumière blanche sur le même plan (monoplan) ou sur deux plans différents décalés (biplan) en acier inoxydable brillant et brossé. Adapté à l'installation dans hammam.

Acquadolce Light: Modell mit Wandarm und Regen-, Wasserfall- und Vernebler-Funktion plus Weißlicht auf dem gleichen Panel (ein Modul). Oder auf zwei übereinander gestaffelten Paneelen (zwei Module). Geeignet auch für Installation in Dampfbädern.

Acquadolce Light: versión con brazo a pared con función lluvia, cascada, nebulizador con luz blanca en el mismo plano (monoplano) o en dos planos diferentes (biplano), en acero brillante o cepillado. También indicado para instalación en hammam.

 **IMQ**  
pending







**ART. L002A - L032B**

Soffione con braccio a parete con funzioni pioggia, cascata, nebulizzatore, luce bianca.

Shower head with wall-mount arm, rainfall, waterfall and mist function, white led light.

Pomme de douche avec bras mural avec fonctions pluie, cascade, brumisateur, lumière blanche.

Kopfbrause mit Wandarm mit Regen, Wasserfall, Vernebler, Weiss Licht.

Rociador con brazo a pared con función lluvia, cascada, nebulizador, luz blanca.







**ART. L002A/L022B -  
D274A/7374B - L102A/L102B  
- 8052**

Soffione con braccio a parete con funzioni pioggia, cascata, nebulizzatore, luce bianca. Miscelatore termostatico incasso 3/4" con deviatore 4 vie. Tastiera di controllo touch per comando luce bianca. Completo doccia.

Shower head with wall-mount arm, rainfall, waterfall and mist function, white led light. 3/4" built-in thermostatic mixer with 4-way diverter. Functions control board for white led light. Shower set.

Pomme de douche avec bras mural avec fonctions pluie, cascade, brumisateur, lumière blanche. Mitigeur thermostatique à encastrer 3/4" avec inverseur 4 voies. Clavier de contrôle touch pour mise en fonctions lumière. Combiné de douche.

Kopfbrause mit Wandarm mit Regen, Wasserfall, Vernebler, Weiss Licht. UP-Thermostatmischer 3/4" mit 4-Wege-Umsteller. Touch-Steuerung als Lampenschalter. Brauseset.

Rociador con brazo a pared con función lluvia, cascada, nebulizador, luz blanca. Monomando termostático empotrado 3/4" con desviador 4 vías. Pulsadores de control touch para control luz. Conjunto de ducha.

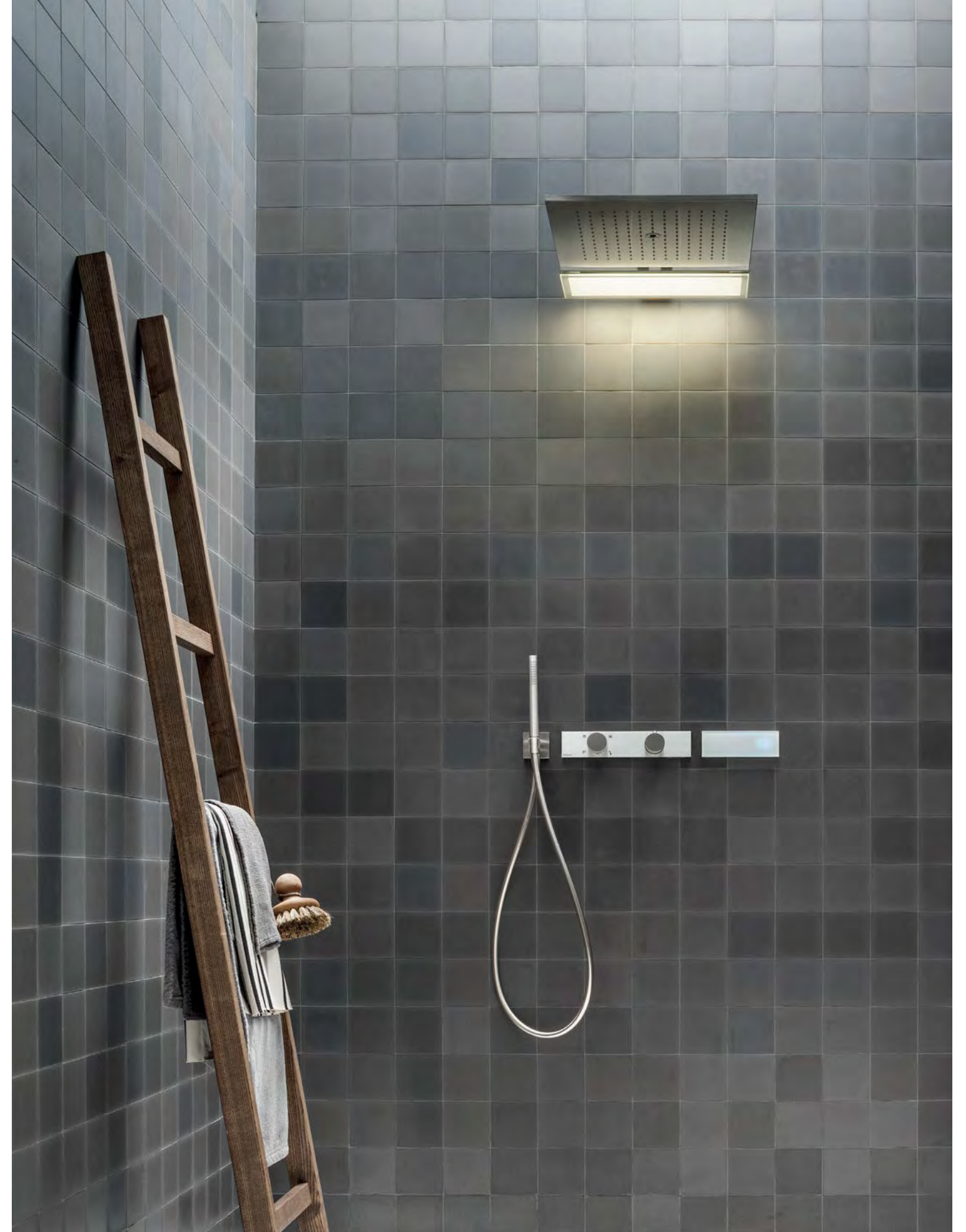

Acquadolce versione da soffitto o con braccio a parete con funzioni pioggia e nebulizzatore. Versione con braccio a parete con funzioni pioggia, cascata, nebulizzatore sullo stesso piano (monoplano) o su due diversi piani sfalsati (biplano), in acciaio lucido e spazzolato.

Acquadolce ceiling-mount or with wall-mount arm and rain and mist functions. Model with wall-mount arm with rain, waterfall and mist functions on the same panel (one module) or on two different staggered panels (two modules), both available in polished or brushed stainless steel.

Acquadolce version plafond ou mural avec bras avec fonctions pluie, brumisateur. Version mural avec bras, avec fonctions pluie, cascade, brumisateur sur le même plan (monoplan) ou sur deux plans différents décalés (biplan), en acier inoxydable brillant et brossé.

Acquadolce Deckenmontiert oder mit Wandarm und Regen- und Vernebler-Funktionen. Modell mit Wandarm mit Regen, Wasserfall und Vernebler auf dem gleichen Paneel (ein Modul), oder auf zwei übereinander gestaffelten Paneelen (zwei Module). Beide Versionen in poliertem oder gebürstetem Edelstahl.

Acquadolce versión a techo o con brazo a pared con función lluvia y nebulizador. Versión con brazo a pared con función lluvia, cascada, nebulizador en el mismo plano (monoplano) o en dos planos diferentes (biplano), en acero brillante y cepillado.





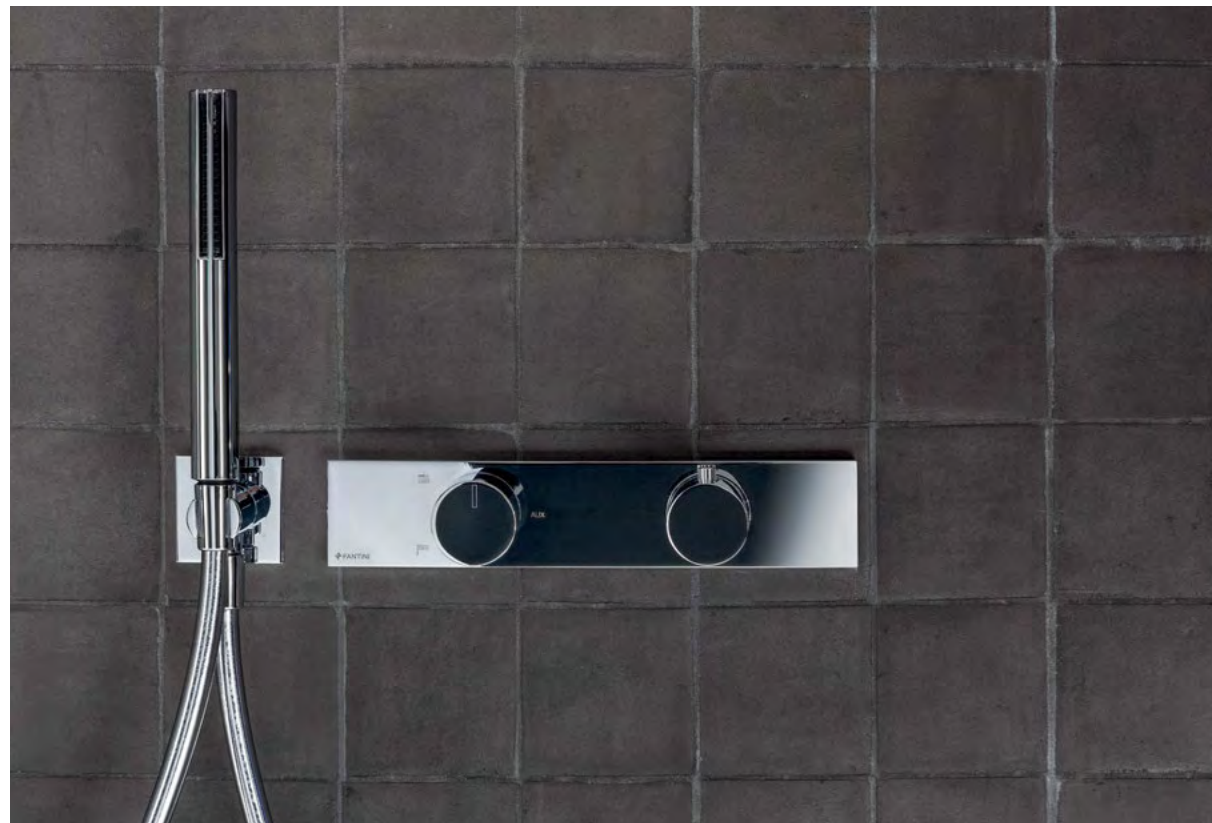

**ART. L001A/L001B -  
D273A/7373B-8052**

Soffione da soffitto con funzioni pioggia e nebulizzazione. Miscelatore termostatico 3/4" incasso con deviatore 3 vie. Completo doccia.

Ceiling shower head rainfall and mist function. 3/4" built-in thermostatic mixer with 3-way diverter. Shower set.

Pomme de douche plafond avec fonctions pluie et brumisateur. Mitigeur thermostatique à encastrer 3/4" avec inverseur 3 voies. Combiné de douche.

Deckenkopfbrause mit Regen und Vernebler. UP- Thermostatmischer 3/4" mit 3-Wege-Umsteller. Brauseset.

Rociador de techo con función lluvia y nebulizador. Monomando termostático empotrado 3/4" con desviador 3 vías. Conjunto de ducha.





**ART. L002A/ L031B -  
D274A/7374B-8052**

Soffione con braccio a parete con funzioni pioggia, cascata, nebulizzazione.  
Miscelatore termostatico 3/4" incasso con deviatore 4 vie.  
Completo doccia.

Showerhead with wall-mount arm, waterfall and mist function.  
3/4" built-in thermostatic mixer with 4-way diverter. Shower set.

Pomme de douche avec bras mural avec fonctions pluie, cascade, brumisateur. Mitigeur thermostatique à encastrer 3/4" avec inverseur 4 voies. Combiné de douche.

Kopfbrause mit Wandarm mit Regen, Wasserfall, Vernebler.  
UP-Thermostatmischer 3/4" mit 4-Wege-Umsteller. Brauseset.

Rociador con brazo a pared con función lluvia, cascada, nebulizador.  
Monomando termostático empotrado 3/4" con desviador 4 vías.  
Conjunto de ducha.





TECHNICAL  
INFORMATIONS

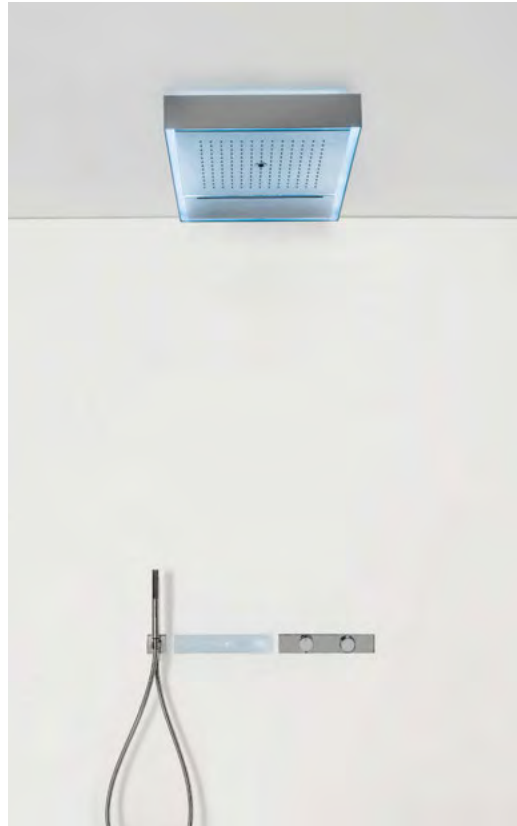

**ART. L051**  
Soffione da soffitto/ Ceiling shower head/  
Pomme de douche plafond/Deckenkopf-  
brause/ Rociador de techo.

**ART. D231A/7331B**  
Miscelatore termostatico/ Thermostatic  
mixer/ Mitigeur thermostatique/ Thermo-  
statmischer/ Monomando termostático.

**ART. L101A/L101B**  
Tastiera di controllo touch/ Touch control  
board/ Clavier de contrôle touch/ Touch-  
Steuerung/ Pulsadores de control touch.

**ART. 8091A/8091B**  
Completo doccia/ Shower set/ Combiné  
de douche/ Brauseset/ Conjunto de ducha.

**Soffione e cascata:** acciaio inossidabile  
lucido. **Cornice:** acciaio inossidabile  
spazzolato/ **Showerhead and waterfall:**  
brilliant stainless steel. **Frame:** brushed  
stainless steel/ **Pomme de douche  
et cascade:** acier inoxydable brillant.  
**Gabarit:** acier inoxydable brossé/  
**Kopfbrause und Wasserfall:** Edelstahl  
poliert. **Rahmen:** Edelstahl gebürstet/  
**Rociador y cascada:** acero inoxidable  
brillante. **Marco exterior perimetral:**  
acero inoxidable cepillado.

**Miscelatore:** acciaio inossidabile  
spazzolato, ottone cromato/ **Mixer:**  
brushed stainless steel, chromed brass/  
**Mitigeur:** acier inoxydable brossé, laiton  
chromé/ **Mischer:** Edelstahl gebürstet,  
Messing Verchromtem/ **Monomando:**  
acero inoxidable cepillado, latón cromado.



**ART. L041**  
Soffione da soffitto/ Ceiling shower head/  
Pomme de douche plafond/Deckenkopf-  
brause/ Rociador de techo.

**ART. D231A/7331B**  
Miscelatore termostatico/ Thermostatic  
mixer/ Mitigeur thermostatique/ Thermo-  
statmischer/ Monomando termostático.

**ART. L101A/L101B**  
Tastiera di controllo touch/ Touch control  
board/ Clavier de contrôle touch/ Touch-  
Steuerung/ Pulsadores de control touch.

**ART. 8091A/8091B**  
Completo doccia/ Shower set/ Combiné  
de douche/ Brauseset/ Conjunto de ducha.

**Soffione e cascata:** acciaio inossidabile  
spazzolato, acciaio inossidabile lucido/  
**Showerhead and waterfall:** brushed  
stainless steel, brilliant stainless steel/  
**Pomme de douche et cascade:** acier  
inoxydable brossé, acier inoxydable  
brillant/ **Kopfbrause und Wasserfall:**  
Edelstahl gebürstet, Edelstahl poliert/  
**Rociador y cascada:** acero inoxidable  
cepillado, acero inoxidable brillante.

**Miscelatore:** acciaio inossidabile  
spazzolato, ottone cromato/ **Mixer:**  
Brushed stainless steel, chromed  
brass/ **Mitigeur:** acier inoxydable brossé,  
laiton chromé/ **Mischer:** Edelstahl gebürstet,  
messing verchromtem/ **Monomando:**  
acero inoxidable cepillado, latón cromado.

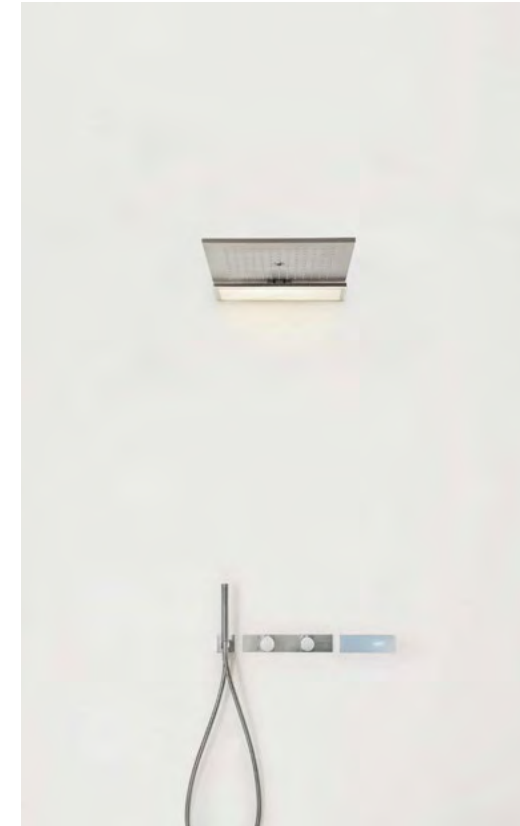

**ART. L002A/L032B**  
Soffione da parete/ Wall-mount shower  
head/ Pomme de douche murale/  
Wandkopfbrause/ Rociador a pared.

**ART. D274A/7374B**  
Miscelatore termostatico/ Thermostatic  
mixer/ Mitigeur thermostatique/ Thermo-  
statmischer/ Monomando termostático.

**ART. L102A/L102B**  
Tastiera di controllo touch/ Touch control  
board/ Clavier de contrôle touch/ Touch-  
Steuerung/ Pulsadores de control touch.

**ART. 8052**  
Completo doccia/ Shower set/ Combiné  
de douche/ Brauseset/ Conjunto de ducha.

**Soffione e cascata:** acciaio inossidabile  
spazzolato, acciaio inossidabile lucido/  
**Showerhead and waterfall:** brushed  
stainless steel, brilliant stainless steel/  
**Pomme de douche et cascade:** acier  
inoxydable brossé, acier inoxydable  
brillant/ **Kopfbrause und Wasserfall:**  
Edelstahl gebürstet, Edelstahl poliert/  
**Rociador y cascada:** acero inoxidable  
cepillado, acero inoxidable brillante.

**Miscelatore:** acciaio inossidabile  
spazzolato, ottone cromato/ **Mixer:**  
brushed stainless steel, chromed brass/  
**Mitigeur:** acier inoxydable brossé, laiton  
chromé/ **Mischer:** Edelstahl gebürstet,  
Messing Verchromtem/ **Monomando:**  
acero inoxidable cepillado, latón cromado.

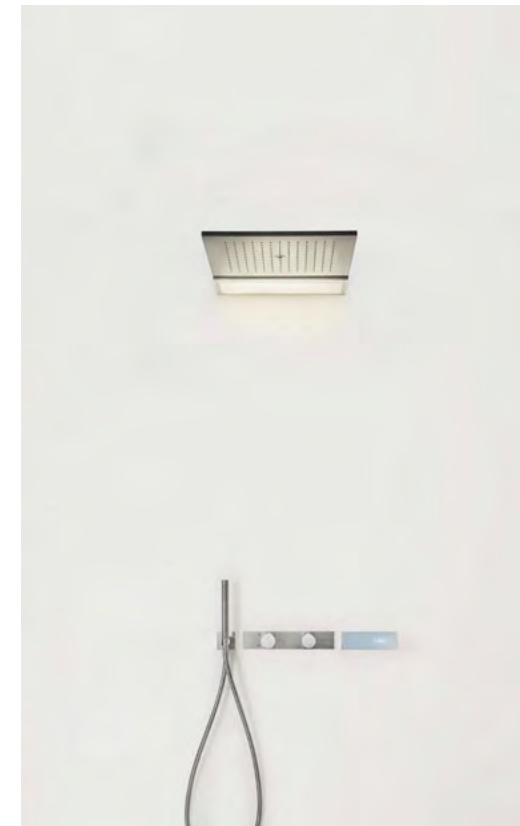

**ART. L002A/L022B**  
Soffione da parete/ Wall-mount shower  
head/ Pomme de douche murale/  
Wandkopfbrause/ Rociador a pared.

**ART. D274A/7374B**  
Miscelatore termostatico/ Thermostatic  
mixer/ Mitigeur thermostatique/ Thermo-  
statmischer/ Monomando termostático.

**ART. L102A/L102B**  
Tastiera di controllo touch/ Touch control  
board/ Clavier de contrôle touch/ Touch-  
Steuerung/ Pulsadores de control touch.

**ART. 8052**  
Completo doccia/ Shower set/ Combiné  
de douche/ Brauseset/ Conjunto de ducha.

**Soffione e cascata:** acciaio inossidabile  
spazzolato, acciaio inossidabile lucido/  
**Showerhead and waterfall:** brushed  
stainless steel, brilliant stainless steel/  
**Pomme de douche et cascade:** acier  
inoxydable brossé, acier inoxydable  
brillant/ **Kopfbrause und Wasserfall:**  
Edelstahl gebürstet, Edelstahl poliert/  
**Rociador y cascada:** acero inoxidable  
cepillado, acero inoxidable brillante.

**Miscelatore:** acciaio inossidabile  
spazzolato, ottone cromato/ **Mixer:**  
brushed stainless steel, chromed brass/  
**Mitigeur:** acier inoxydable brossé, laiton  
chromé/ **Mischer:** Edelstahl gebürstet,  
messing verchromtem/ **Monomando:**  
acero inoxidable cepillado, latón cromado.

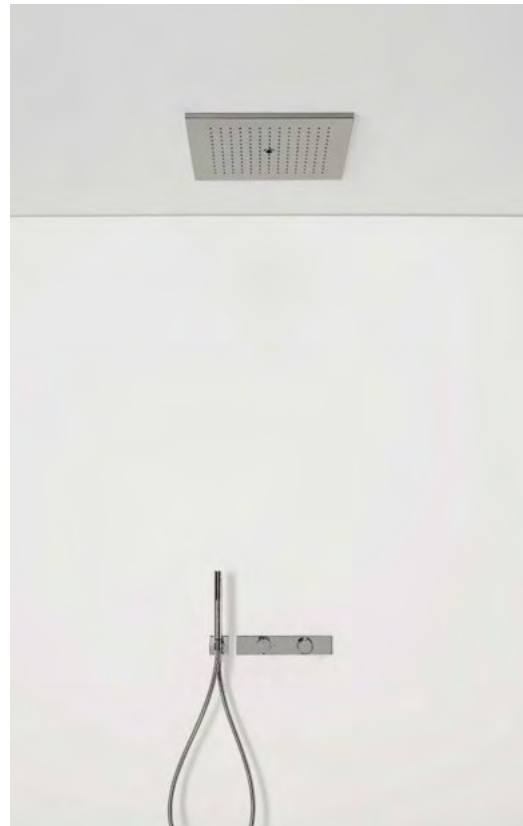
**ART. L001A/L001B**

Soffione da soffitto/ Ceiling shower head/  
Pomme de douche plafond/Deckenkopf-  
brause/ Rociador de techo.

**ART. D273A/7373B**

Miscelatore termostatico/ Thermostatic  
mixer/ Mitigeur thermostatique/ Thermo-  
statmischer/ Monomando termostático.

**ART. 8052**

Completo doccia/ Shower set/ Combiné  
de douche/ Brauseset/ Conjunto de ducha.

**Soffione:** acciaio inossidabile spazzolato,  
acciaio inossidabile lucido/ **Showerhead:**  
brushed stainless steel, brilliant stainless  
steel/ **Pomme de douche:** acier inoxy-  
dable brossé, acier inoxydable brillant/  
**Kopfbrause:** Edelstahl gebürstet, Edelstahl  
poliert/ **Rociador:** acero inoxidable cepilla-  
do, acero inoxidable brillante.

**Miscelatore:** acciaio inossidabile  
spazzolato, ottone cromato/  
**Mixer:** brushed stainless steel, chromed  
brass/ **Mitigeur:** acier inoxydable brossé,  
laiton chromé/ **Mischer:** Edelstahl gebürs-  
tet, Messing Verchromtem/  
**Monomando:** acero inoxidable cepillado,  
latón cromado.

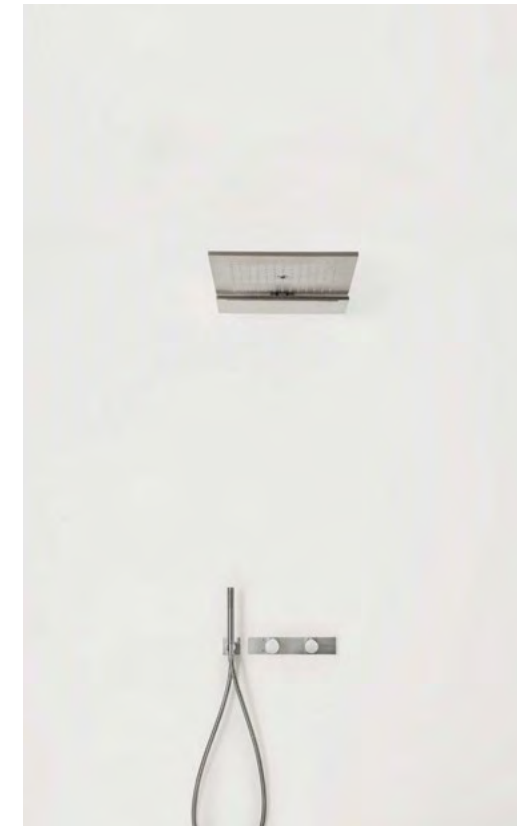
**ART. L002A/L031B**

Soffione da parete/ Wall-mount shower  
head/ Pomme de douche murale/  
Wandkopfbrause/ Rociador a pared.

**ART. D274A/7374B**

Miscelatore termostatico/ Thermostatic  
mixer/ Mitigeur thermostatique/ Thermo-  
statmischer/ Monomando termostático.

**ART. 8052**

Completo doccia/ Shower set/ Combiné  
de douche/ Brauseset/ Conjunto de ducha.

**Soffione:** acciaio inossidabile spazzolato,  
acciaio inossidabile lucido/ **Showerhead:**  
brushed stainless steel, brilliant stainless  
steel/ **Pomme de douche:** acier inoxy-  
dable brossé, acier inoxydable brillant/  
**Kopfbrause:** Edelstahl gebürstet, Edelstahl  
poliert/ **Rociador:** acero inoxidable cepilla-  
do, acero inoxidable brillante.

**Miscelatore:** acciaio inossidabile  
spazzolato, ottone cromato/  
**Mixer:** brushed stainless steel, chromed  
brass/ **Mitigeur:** acier inoxydable brossé,  
laiton chromé/ **Mischer:** Edelstahl gebürs-  
tet, Messing Verchromtem/  
**Monomando:** acero inoxidable cepillado,  
latón cromado.

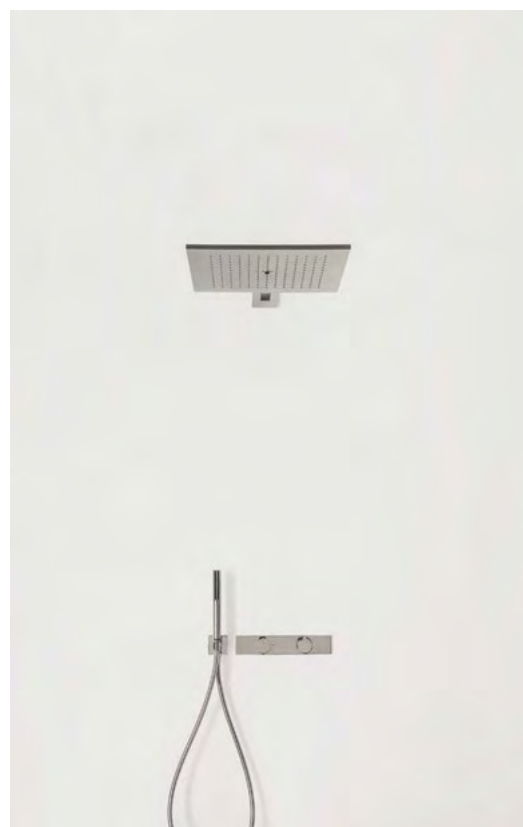
**ART. L003A/L011B**

Soffione da parete/ Wall-mount shower  
head/ Pomme de douche murale/  
Wandkopfbrause/ Rociador a pared.

**ART. D273A/7373B**

Miscelatore termostatico/ Thermostatic  
mixer/ Mitigeur thermostatique/ Thermo-  
statmischer/ Monomando termostático.

**ART. 8052**

Completo doccia/ Shower set/ Combiné  
de douche/ Brauseset/ Conjunto de ducha.

**Soffione:** acciaio inossidabile spazzolato,  
acciaio inossidabile lucido/ **Showerhead:**  
brushed stainless steel, brilliant stainless  
steel/ **Pomme de douche:** acier inoxy-  
dable brossé, acier inoxydable brillant/  
**Kopfbrause:** Edelstahl gebürstet, Edelstahl  
poliert/ **Rociador:** acero inoxidable cepilla-  
do, acero inoxidable brillante.

**Miscelatore:** acciaio inossidabile  
spazzolato, ottone cromato/  
**Mixer:** brushed stainless steel, chromed  
brass/ **Mitigeur:** acier inoxydable brossé,  
laiton chromé/ **Mischer:** Edelstahl gebürs-  
tet, Messing Verchromtem/  
**Monomando:** acero inoxidable cepillado,  
latón cromado.

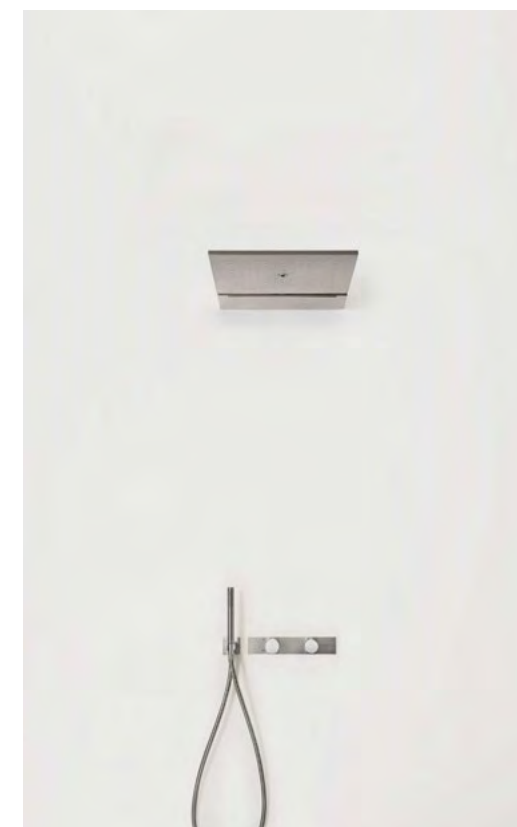
**ART. L002A/L021B**

Soffione da parete/ Wall-mount shower  
head/ Pomme de douche murale/  
Wandkopfbrause/ Rociador a pared.

**ART. D274A/7374B**

Miscelatore termostatico/ Thermostatic  
mixer/ Mitigeur thermostatique/ Thermo-  
statmischer/ Monomando termostático.

**ART. 8052**

Completo doccia/ Shower set/ Combiné  
de douche/ Brauseset/ Conjunto de ducha.

**Soffione:** acciaio inossidabile spazzolato,  
acciaio inossidabile lucido/ **Showerhead:**  
brushed stainless steel, brilliant stainless  
steel/ **Pomme de douche:** acier inoxy-  
dable brossé, acier inoxydable brillant/  
**Kopfbrause:** Edelstahl gebürstet, Edelstahl  
poliert/ **Rociador:** acero inoxidable cepilla-  
do, acero inoxidable brillante.

**Miscelatore:** acciaio inossidabile  
spazzolato, ottone cromato/  
**Mixer:** brushed stainless steel, chromed  
brass/ **Mitigeur:** acier inoxydable brossé,  
laiton chromé/ **Mischer:** Edelstahl gebürs-  
tet, Messing Verchromtem/  
**Monomando:** acero inoxidable cepillado,  
latón cromado.

ART. L051

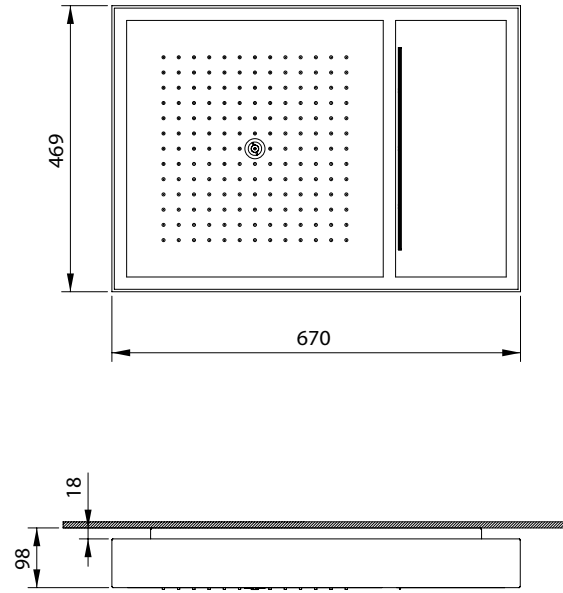

ART. L041

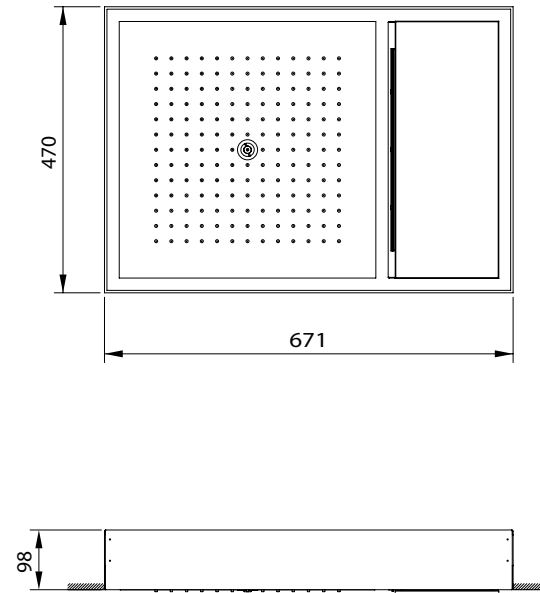

ART. L101A/L101B

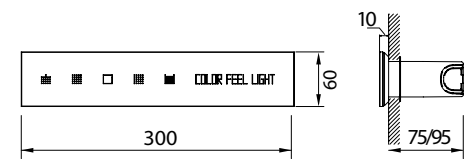

ART. L002A/L032B

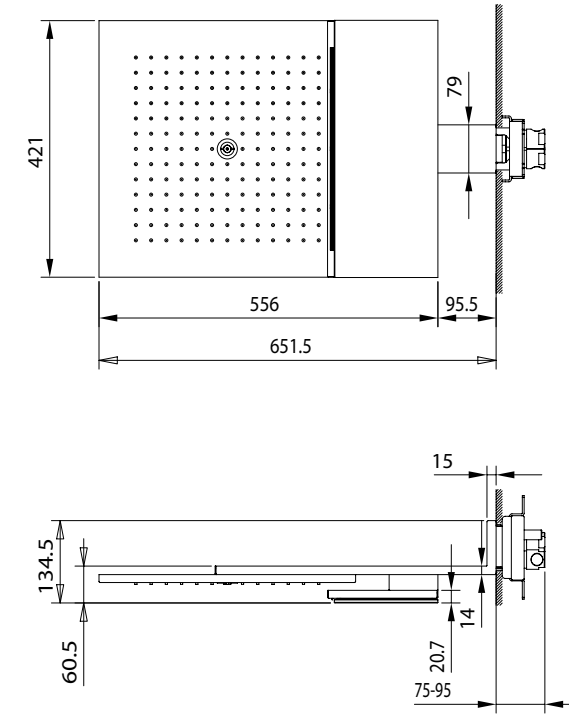

ART. L002A/L022B

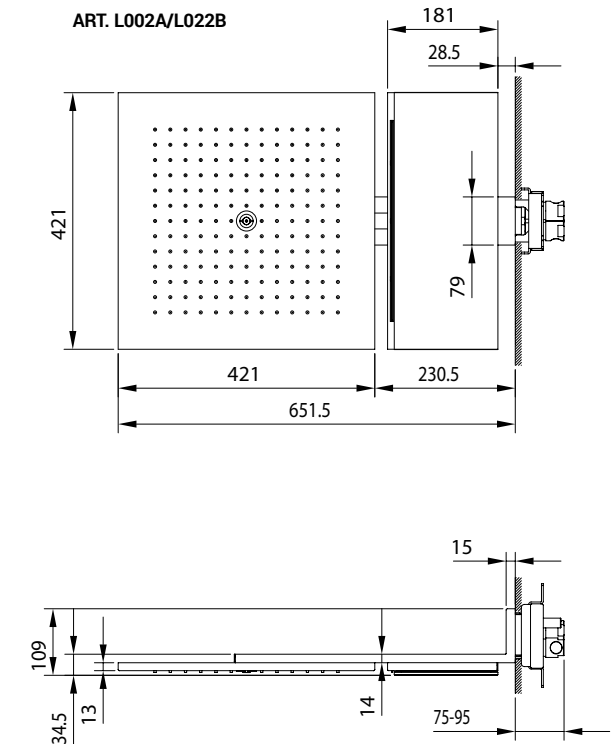

ART. L102A/L102B

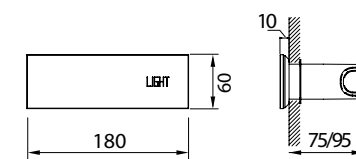

ART. L001A/L001B

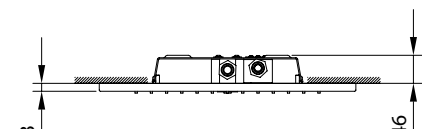
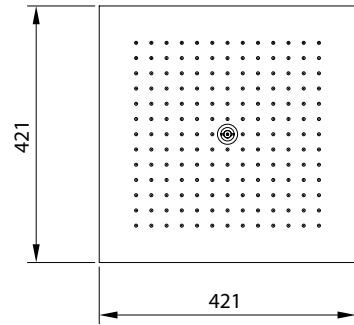

ART. L003A/L011B

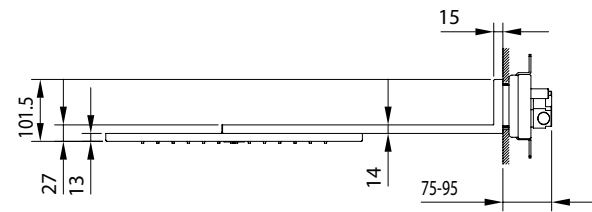
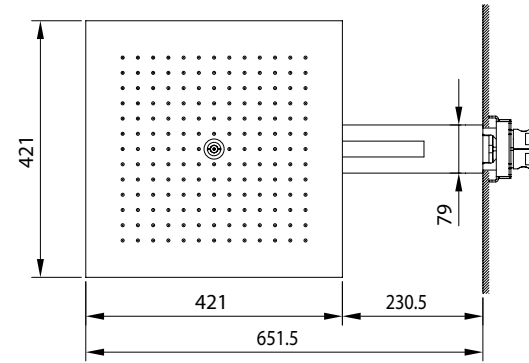

ART. L002A/L031B

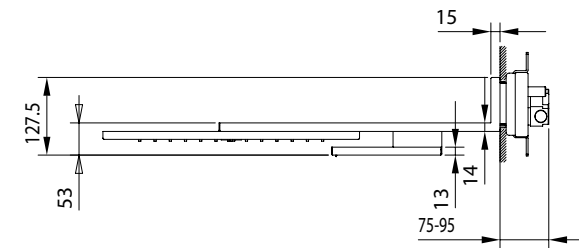
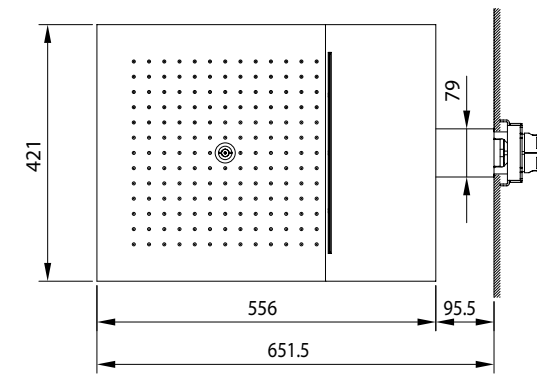

ART. L002A/L021B

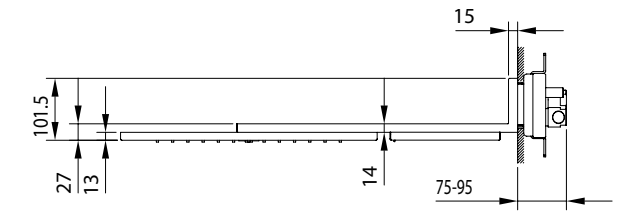
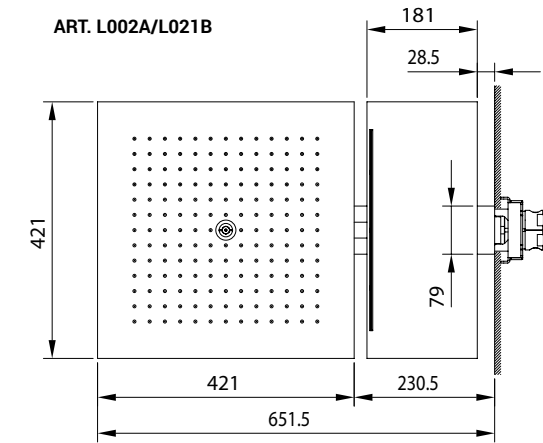

Cod: 110000320REV0000

**AD:** Graph.x  
**Ph:** Santi Caleca  
**Ph:** Assistant/ Thomas Pagani  
**Styling:** Studio Salaris  
**Fotolito:** CD Cromo  
**Stampa:** Tipolitografia Saccardo  
Aprile 2015

**Thanks to:**

Aesop  
/distribuito in esclusiva  
in Italia da Olfattorio/  
Boffi  
Carl Hansen  
Ceccotti Collezioni  
Cuore Di Lino  
Domenico Mori  
Gallotti & Radice  
Giulio Tanini  
Ilaria I  
Mogg  
Mutina  
Salvatori  
Scandola  
Vitra

L'azienda si riserva in qualunque momento di apportare senza preavviso modifiche a prodotti e accessori.  
The Manufacturer reserves the right to modify products and accessories at any time without prior notice.  
Der Hersteller behält sich das Recht vor, jederzeit Änderungen an seinen Produkten und Zubehörteilen ohne Vorbescheid vorzunehmen.  
La société se réserve le droit de modifier ses produits et ses accessoires à tout moment et sans préavis.  
La Sociedad se reserva el derecho de modificar sus productos y accesorios en cualquier momento y sin previo aviso.





**Fratelli Fantini Spa** Via M. Buonarroti, 4 I - 28010 Pella (NO)  
tel. +39 0322 918411 fax. +39 0322 969530 [fantini@fantini.it](mailto:fantini@fantini.it) [www.fantini.it](http://www.fantini.it)