

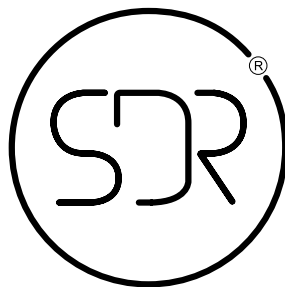

Il punto di partenza è la tensione verso la bellezza, verso l'arte, in modo che la sorpresa, lo stupore, l'inatteso siano parte anche dell'opera architettonica.

The starting point is the tension towards beauty, towards art, so that surprise, amazement, the unexpected are also part of the architectural work.

(Oscar Niemeyer)





Artigianalità. Craftsmanship.

L'impronta del "fatto a mano"
è per SDR elemento di distinzione
e garanzia di professionalità.

The "handmade" mark is for SDR
an element of distinction and
a guarantee of professionalism.



Quello che emerge dal prodotto SDR è il tratto
artigiano che distingue ogni prodotto e ne
restituisce prestigio e unicità: cura del dettaglio,
ricerca attenta di materiali ed eleganza
nell'espressione finale del concept.

What emerges from the SDR product is the
artisan touch that distinguishes each product
and gives it prestige and uniqueness: attention
to detail, careful research of materials and
elegance in the final expression of the concept.

Tutti i colori della ceramica. All the ceramic colors.

SDR propone una palette di colori che meglio si prestano ad essere coordinati ai bagni che siano moderni, contemporanei o classici.

SDR offers a color selection usefull with modern, contemporary or classic bathrooms.

Bisogna partire sempre dal presupposto che quando si deve scegliere il colore o i colori con i quali arredare la propria casa, non vige una regola generale. **Il primo fattore da seguire è quello di scegliere ciò che ci piace.** 5 sono i colori NUANCE (Beige, Verde, Celeste, Rosa e Grigio) e i colori ESSENCE (Sabbia, Caffè, Grafite, Magnesio e Ghiaccio) e i classici Bianco Lucido e Panna che SDR propone per tutti i prodotti ceramici a catalogo.

To choose a color to decorate your home there are not a general rule. The first aim is to follow your taste. SDR propose is 5 NUANCE colors (Beige, Verde, Celeste, Rosa and Grigio), ESSENCE colors (Sabbia, Caffè, Grafite, Magnesio and Ghiaccio) and the classic Bianco Lucido and Panna that SDR proposes for all the ceramic products in the catalogue.





ESSENCE

Per un bagno classico la scelta solitamente è tradizionale e ricade su tinte neutre come il Sabbia e il Ghiaccio. Per un tocco più personale scegliete anche un colore a contrasto come il Caffè o il Magnesio per passare al Grafite di sicuro effetto.

For a classic bathroom the choice is usually traditional and falls back on neutral colors such as Sabbia and Ghiaccio. For a more personal touch also choose a contrasting color such as Caffè or Magnesio or switch to Grafite for a sure effect.

BIANCO LUCIDO
PANNA
SABBIA
CAFFÈ
GRAFITE
MAGNESIO
GHIACCIO

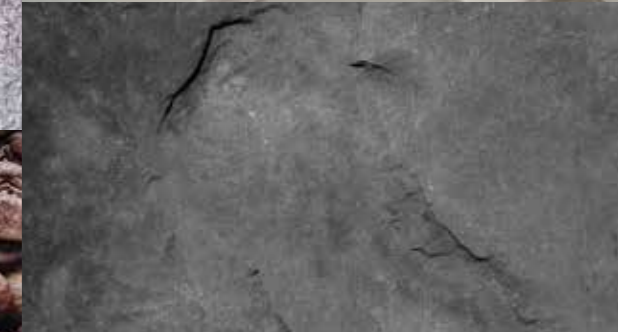



NUANCE

Colori tenui che hanno la capacità di abbinarsi facilmente a tutte le scelte cromatiche, senza nessuna "Arroganza, Prepotenza, Invadenza", ma con la Delicatezza e la Discrezione di nuove tonalità pastello valide alternative al bianco lucido.

Soft colors have the ability to easily match all chromatic choices, without any "Arrogance or power", but with the Delicacy and Discretion of new pastel shades; valid alternatives to glossy white.

BEIGE
VERDE
CELESTE
ROSA
GRIGIO





REVOLUTION

Le rivoluzioni, coraggiosamente segnano un nuovo punto di partenza. SDR mette in atto all'interno del mondo del bagno una trasformazione radicale. Il capovolgimento di un ordine. la superficie è solida (solid surface) omogenea, non porosa ed estremamente liscia. La collezione di sanitari prodotta in Livin-Stone® composta da vaso e bidet sospesi, lavabi e vasche. Proposta in quattro colorazioni differenti (Cotone, Camelia, Avio, Aloe), REVOLUTION® si caratterizza per i suoi "spigoli vivi" attorno al perimetro, le superfici perfette.

Revolutions boldly mark a new starting point. SDR implements a radical transformation within the bathroom world. The reversal of an order. the surface is solid (solid surface) homogeneous, non-porous and extremely smooth. The sanitaryware collection produced in Livin-Stone® consists of a suspended toilet and bidet, washbasins and bathtubs. Proposed in four different colors (Cotton, Camelia, Avio, Aloe), REVOLUTION® is characterized by its "sharp edges" around the perimeter, perfect surfaces

**COTONE
CAMELIA
AVIO
ALOE**



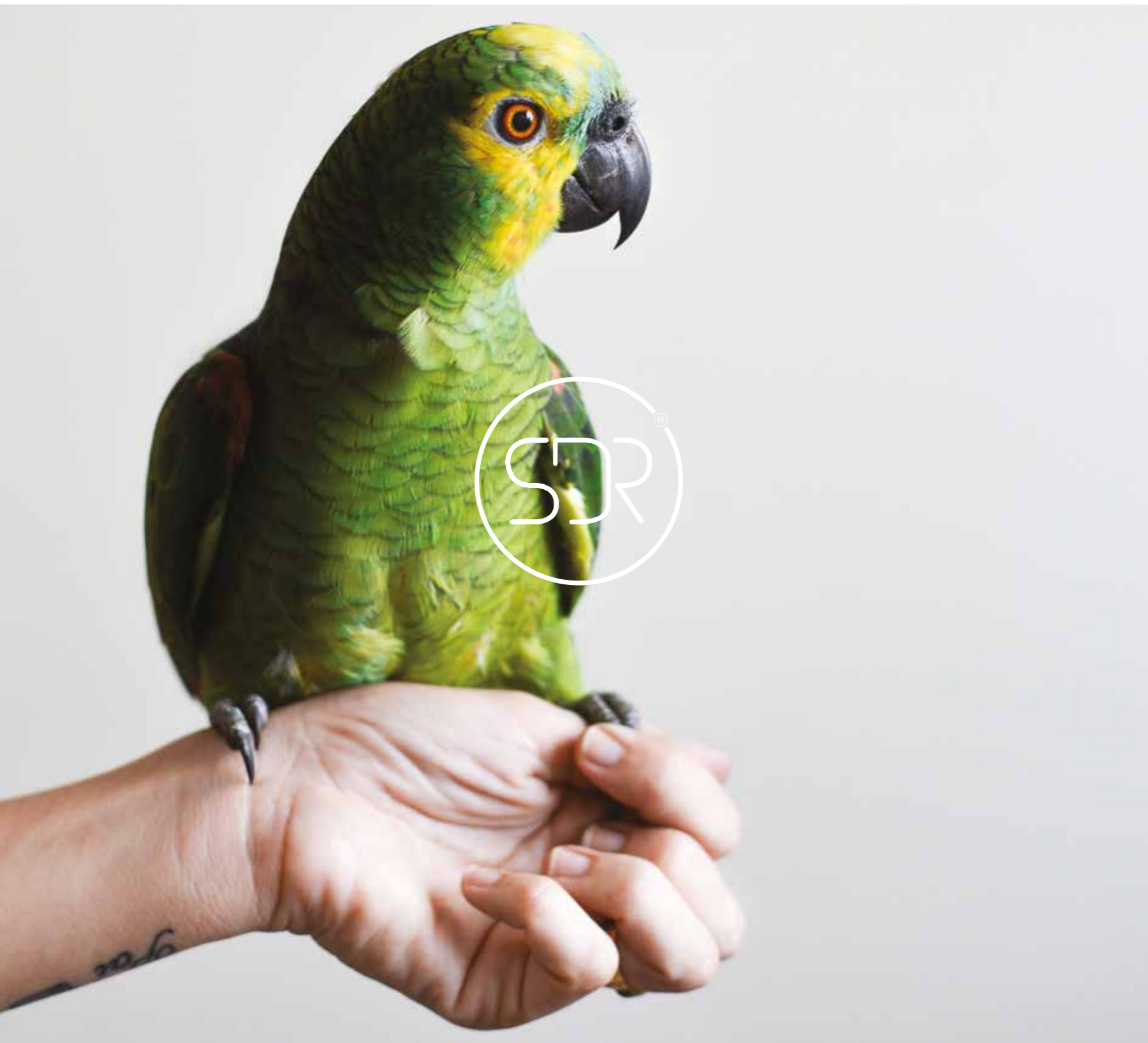

INDICE | SUMMARY

BULLp. 14
QUADRAp. 28
NEOSp. 42
FOXp. 56
BULL500p. 70

Revolution _ p. 84

COTONEp. 92
 CAMELIAp. 102
 ALOEp. 112
 AVIOp. 124

**Lavabi d'arredo _
 Washbasins p. 134**

CERAMICAp. 136
 REVOLUTIONp. 156
 LIVIN-STONE®p. 158

**Vasche free-standing _
 Free-standing Bathtubs p. 170**

BULLp. 172
 QUADRAp. 174
 OVALE REVOLUTIONp. 176
 QUADRA REVOLUTIONp. 177

**Piatti doccia _
 Shower trays p. 178**

LONG LIFE (Ceramica)p. 186
 ENIGMA (Pietraluce)p. 202

**Mobili & Top _
 Furniture & Tops p. 218**

SOLIDOp. 220
 REVOLUTIONp. 226

**Rubinetti e accessori King _
 Taps and accessories p. 234**

**Area tecnica _
 Technical area p. 244**



SCAN ME



B

#BULL

Forme sinuose che danno sicurezza, una collezione piacevole e infinita per le sue curve morbide, dal sapore femminile. La linea è composta da molti lavabi utili per ogni uso e versatile ad ogni situazione e spazio.

Dal minimal al fashion più aggressivo... per Bull c'è sempre un posto riservato.

Sinuous shapes that give security, a pleasant and infinite collection for its soft curves, with a feminine touch. This line consists of many useful washbasins for every use and versatile in every situation and space.

From minimal to more aggressive... for Bull there is always a reserved place.

#BULL A TERRA



BULL

#Panna





Vaso Bull a terra Rosa Nuance / Bull BTW Wc Rosa Nuance finish
 Coprivaso Bull soft-close a sgancio rapido Rosa Nuance / Soft close quick-release seat cover Rosa Nuance finish
 Bidet Bull a terra Rosa Nuance / Bull BTW single hole bidet Rosa Nuance finish



Vertigo è il nuovo sistema di scarico SDR Ceramiche che permette uno scarico più confortevole, meno rumoroso al momento del deflusso e che garantisce migliori standard igienici rispetto al classico sanitario con o senza la brida. Inoltre il nuovo sistema Vertigo permette una miglior compatibilità con tutte le batterie di scarico in commercio rispetto al No-Rim.

Vertigo, the new SDR Ceramiche flushing system that allows a more comfortable, less noisy and which guarantees better hygienic standards than the classic flushing system with or without the rim. Furthermore the new Vertigo system allows for better compatibility with all the flushing systems in the market.



#Magnesio Essence

Piatto doccia Long Life 80x170 Magnesio /
Long Life shower tray 80x170 Magnesio finish



#Grigio Nuance

La vasca BULL realizzata in Livin-Stone® (Solid Surface), un materiale antibatterico studiato per soddisfare i più alti standard di qualità tecnologica, impatto ambientale e igienicità mai raggiunti prima. La superficie perfetta, senza alcuna irregolarità, la pulizia delle forme, gli spessori e le sue linee morbide conferiscono alla vasca centro stanza una contemporaneità senza tempo.

BULL bathtub made of Livin-Stone® (Solid Surface), an antibacterial material designed to meet the highest standards of technological quality, environmental impact and hygiene never achieved before. The perfect surface, without any irregularity, the thicknesses and the clean and soft lines give the freestanding bathtub a timeless contemporaneity.



#BULL #SOSPESA

#Sabbia Essence





Vaso Bull sospeso Grafite / Bull wall-hung wc Grafite finish
Coprivaso Bull soft-close a sgancio rapido Grafite / Soft close quick-release seat cover Grafite finish
Bidet Bull sospeso Grafite / Bull wall-hung single hole bidet Grafite finish



#Grafite Essence

BULL

SDR ha progettato i sanitari della serie BULL (qui in versione sospesa) che anticipano le tendenze dell'abitare, le linee curve e geometrie precise assecondano il materiale ceramico aumentandone il valore. I volumi sono calibrati ed il loro impatto estetico unico e sorprendente unisce il pratico al bello.

SDR has designed the BULL series sanitary ware (here in the suspended version) that anticipate living trends; the curved lines and precise geometries nourish the ceramic material increasing its value. The volumes are calibrated and their unique and amazing aesthetic impact combines practicality with beauty.



#Verde Nuance

Piatto doccia Long Life 80x130 Verde Nuance /
Long Life shower tray 80x130 Verde Nuance finish
Vaso Bull sospeso Verde Nuance / Bull wall-hung Wc Verde Nuance finish
Copri vaso Bull soft-close a sgancio rapido Verde Nuance /
Soft close quick-release seat cover Verde Nuance finish
Bidet Bull sospeso Verde Nuance / Bull wall-hung single hole bidet Verde Nuance finish



#Verde Nuance

Mobile Solido cm 120x46 Verde Nuance + top con vasca integrata sx /
Solido Cabinet 120 cm Verde Nuance finish + top with built-in washbasin on the left
Miscelatore monocomando Lavabo / Single lever basin mixer
Specchio touch-screen retro illuminato Led / Backlit Led mirror with touch ON/OFF sensor switch

Q

QUADRA

Design dal gusto deciso ma allo stesso tempo morbido ed elegante. Una linea immaginata per uno spazio architettonico senza tempo dove tutte le forme possono coesistere.

Decisive taste design but at the same time elegant and soft. An imaginary line for a timeless architectural space, where all shapes can coexist.

#QUADRA A TERRA





#Grafite Essence

Vaso Quadra a terra Grafite / Quadra BTW Wc Grafite finish
 Coprivaso Quadra soft-close a sgancio rapido Grafite / Soft close quick-release seat cover Grafite finish
 Bidet Quadra a terra Grafite / Quadra BTW single hole bidet Grafite finish



Vertigo è il nuovo sistema di scarico SDR Ceramiche che permette uno scarico più confortevole, meno rumoroso al momento del deflusso e che garantisce migliori standard igienici rispetto al classico sanitario con o senza la brida. Inoltre il nuovo sistema Vertigo permette una miglior compatibilità con tutte le batterie di scarico in commercio rispetto al No-Rim.

Vertigo, the new SDR Ceramiche flushing system that allows a more comfortable, less noisy and which guarantees better hygienic standards than the classic flushing system with or without the rim. Furthermore the new Vertigo system allows for better compatibility with all the flushing systems in the market.



#Beige Nuance

QUADRA

#Caffè Essence



Piatto doccia Long Life 80x180 Caffè / Long Life shower tray 80x130 Caffè finish

Catalogo Generale

#Panna Essence

Lavabi monolitici Qube 7 Panna / Qube 7 free standing washbasins Panna finish
Specchi touch-screen retro illuminati Led / Backlit Led mirrors with touch ON/OFF sensor switch

#QUADRA SOSPESA

#Panna Essence





#Grafite Essence

Mobile Solido cm 120x46 Grafite + Lavabo Qube 11 Grafite / Solido Cabinet 120x46 cm Grafite finish + Qube 11 washbasin Grafite finish
Specchio touch-screen retro illuminato Led / Backlit Led mirror with touch ON/OFF sensor switch



Vertigo è il nuovo sistema di scarico SDR Ceramiche che permette uno scarico più confortevole, meno rumoroso al momento del deflusso e che garantisce migliori standard igienici rispetto al classico sanitario con o senza la brida. Inoltre il nuovo sistema Vertigo permette una miglior compatibilità con tutte le batterie di scarico in commercio rispetto al No-Rim.

Vertigo, the new SDR Ceramiche flushing system that allows a more comfortable, less noisy and which guarantees better hygienic standards than the classic flushing system with or without the rim. Furthermore the new Vertigo system allows for better compatibility with all the flushing systems in the market.

Vaso Quadra sospeso Grafite / Quadra wall-hung Wc Grafite finish
Coprivaso Quadra soft-close a sgancio rapido Grafite / Soft close quick-release seat cover Grafite finish
Bidet Quadra sospeso Grafite / Quadra wall-hung single hole bidet Grafite finish



#Grafite Essence



#Sabbia Essence

Sempre elegante ed essenziale, la vasca Quadra free-standing in Livin-Stone® si può posizionare al centro del bagno, se l'ambiente è ampio. In una stanza di dimensioni contenute, invece, la vasca è installabile anche vicino la parete, angolo o nicchia con il miscelatore per vasca incassato a muro.

Elegant and essential freestanding bathtub in Livin-Stone® Quadra can be placed in the center of the bathroom, if the area is large. In a small room, the bathtub can be installed near the wall, corner or recess with the wall bathtub mixer.

N

NEOS

Elementi d'arredo dalle forme pure, essenziali e volutamente dedicate alla cura del sé, modellate dallo scorrere della luce che ne definisce i volumi della serie. La collezione è composta da elementi a terra o in versione sospesa, declinabili in tutte le colorazioni SDR per vestire al meglio ogni esigenza di arredo.

Pure and essential shapes of the furnishing elements, deliberately dedicated to self-care, shaped by the flow of light that defines the volumes of the object. The collection is available floor-standing or wall mounted all can be declined in the SDR colors to best suit every furnishing need.

#NEOS A TERRA



NEOS

46



#Ghiaccio Essence

Vaso Neos a terra Ghiaccio / Neos BTW Wc Ghiaccio finish
 Copri vaso Neos soft-close a sgancio rapido Ghiaccio / Soft close quick-release seat cover Ghiaccio finish



Vertigo è il nuovo sistema di scarico SDR Ceramiche che permette uno scarico più confortevole, meno rumoroso al momento del deflusso e che garantisce migliori standard igienici rispetto al classico sanitario con o senza la brida. Inoltre il nuovo sistema Vertigo permette una miglior compatibilità con tutte le batterie di scarico in commercio rispetto al No-Rim.

Vertigo, the new SDR Ceramiche flushing system that allows a more comfortable, less noisy and which guarantees better hygienic standards than the classic flushing system with or without the rim. Furthermore the new Vertigo system allows for better compatibility with all the flushing systems in the market.

Catalogo Generale

Vaso Neos a terra Beige Nuance / Neos BTW Wc Beige Nuance finish
 Copri vaso Neos soft-close a sgancio rapido Beige Nuance / Soft close quick-release seat cover Beige Nuance finish
 Bidet Neos a terra Beige Nuance / Neos BTW single hole bidet Beige Nuance finish
 Lavabo sospeso Pool 5 Beige Nuance / Pool 5 wall-hung washbasin Beige Nuance finish
 Specchio touch-screen retro illuminato Led / Backlit Led mirror with touch ON/OFF sensor switch

47



#Beige Nuance

SDR propone i nuovi lavabi sospesi POOL di 3 diverse larghezze in ceramica: 42, 62 e 92 cm con forme eleganti che si adattano alla perfezione in qualsiasi tipologia di ambiente bagno che sia di dimensioni contenute o dallo stile minimal o classico.

SDR offers you the new POOL wall mounted ceramic washbasins, in 3 different widths 42, 62, 92 cm, elegant shapes that will be able to adapt perfectly to any type of bathroom environment whether it is small in size or with a minimal or classic style.



#Magnesio Essence

Lavabo sospeso Pool 5 Magnesio / Pool 5 wall-hung washbasin Magnesio finish
Specchio touch-screen retro illuminato Led / Backlit Led mirror with touch ON/OFF sensor switch



#Celeste Nuance

Piatto doccia Long Life 80x140 Celeste Nuance / Long Life shower tray 80x140 Celeste Nuance finish

**#NEOS
SOSPESA**



#Sabbia Essence

Vaso Neos sospeso Sabbia / Neos wall-hung Wc Sabbia finish
 Coprivaso Neos soft-close a sgancio rapido Sabbia / Soft close quick-release seat cover Sabbia finish
 Bidet Neos sospeso Sabbia / Neos wall-hung single hole bidet Sabbia finish



Vertigo è il nuovo sistema di scarico SDR Ceramiche che permette uno scarico più confortevole, meno rumoroso al momento del deflusso e che garantisce migliori standard igienici rispetto al classico sanitario con o senza la brida. Inoltre il nuovo sistema Vertigo permette una miglior compatibilità con tutte le batterie di scarico in commercio rispetto al No-Rim.

Vertigo, the new SDR Ceramiche flushing system that allows a more comfortable, less noisy and which guarantees better hygienic standards than the classic flushing system with or without the rim. Furthermore the new Vertigo system allows for better compatibility with all the flushing systems in the market.



#Caffè Essence



Consolle Revolution 95 Panna / Revolution 95 console Panna finish
Cassetto Revolution 30 Panna / Revolution 30 drawer Panna finish



La vasca BULL realizzata in Livin-Stone® (Solid Surface), la superficie perfetta, senza alcuna irregolarità, la pulizia delle forme, gli spessori e le sue linee morbide conferiscono alla vasca centro stanza una contemporaneità senza tempo.

BULL bathtub made of Livin-Stone® (Solid Surface), the perfect surface, without any irregularity, the thicknesses and the clean and soft lines give the freestanding bathtub a timeless contemporaneity.

#Panna Essence

F

FOX

La semplicità delle forme e la decisione dei tratti caratterizzano la collezione Fox che utilizza il coprivaso Slim con sgancio rapido. La nuova serie è sviluppata nella versione a terra e sospesa. Il vaso a terra è predisposto per lo scarico traslato fino a 180 mm.

The simple forms and the strong lines characterize the FOX collection that uses the Slim seat cover with quick release system. This new series, in its back to wall or wall-hung version. The back to wall toilet is available with the translated drain system up to 180 mm.

#FOX
A TERRA





La stanza da bagno diventa subito elegante grazie al lavabo free-standing QUBE 7 ridefinendo così lo spazio con armonia. Il lavabo monolitico è in Livin-Stone®, è facile da pulire, non ingiallisce e il suo colore non perde tono nel corso del tempo.

The bathroom immediately becomes elegant thanks to the QUBE 7 free-standing washbasin that redefines the space with harmony. The monolithic washbasin is in Livin-Stone®, easy to clean, does not turn yellow and its color does not lose tone over time.



Vaso Fox a terra Bianco Lucido / Fox BTW Wc Bianco Lucido finish
Coprivaso Fox soft-close a sgancio rapido Bianco Lucido / Soft close quick-release seat cover Bianco Lucido finish
Bidet Fox a terra Bianco Lucido / Fox BTW single hole bidet Bianco Lucido finish

I bordi sono a "spigolo vivo" - non più rotondi come avviene nelle classiche vasche in ceramica - esaltando il design unico della vasca freestanding Bull in Livin-Stone®, un materiale atossico, antibatterico, inerte, ipoallergenico e ignifugo che oltre ad offrire alte prestazioni funzionali ed estetiche, è facilmente ripristinabile e riciclabile, rientrando, così, tra i materiali definiti "eco-compatibili".

The edges are no longer round - like in classic bathtubs - enhancing the unique design of the Bull freestanding bathtub in Livin-Stone®, a non-toxic, antibacterial, inert, hypoallergenic and fireproof material that in addition to offering high functional and aesthetic performance, is easily restorable and recyclable and can therefore be defined as "eco-friendly".



#FOX
SOSPESA

#Bianco Lucido



Il bagno diventa uno spazio da personalizzare in ogni dettaglio secondo il proprio gusto, scegliendo sinuosi sanitari sospesi Fox dagli alti standard qualitativi realizzati con fine ceramica nella colorazione PANNA. Tutti i sanitari sospesi SDR hanno il sistema di fissaggio completamente nascosto. Vengono forniti completi di kit che permettono di ancorarli sulle staffe metalliche installate a parete con estrema facilità.

The bathroom becomes a space to personalize in every detail according to one's taste, choosing Fox sinuous sanitary fixtures with high quality standards made with fine ceramic in PANNA color. Each SDR suspended sanitary ware has a completely hidden fixing system and is supplied with kits that allow it to be easily anchored to the metal brackets installed on the wall.



#Panna Essence



Vaso Fox sospeso Bianco Lucido / Neos wall-hung Wc Bianco Lucido finish
Coprivaso Fox soft-close a sgancio rapido Bianco Lucido / Soft close quick-release seat cover Bianco Lucido finish
Bidet Fox sospeso Bianco Lucido / Fox wall-hung single hole bidet Bianco Lucido finish

#Bianco Lucido



#Panna Essence



Lavabi Flat 1 Panna / Flat 1 washbasins Panna finish
Specchi touch-screen retro illuminato Led / Backlit Led mirrors with touch ON/OFF sensor switch



#Bianco Lucido

Lavabi Flat 2 Bianco Lucido / Flat 1 washbasins Bianco Lucido finish
Specchi touch-screen retro illuminato Led / Backlit Led mirrors with touch ON/OFF sensor switch

B5

BULL500

Questa collezione è stata progettata per soddisfare la necessità di avere dei sanitari più contenuti. Le linee attuali ne fanno un prodotto adatto ad un pubblico giovane e attento alle novità. Il wc Bull500 è disponibile con lo scarico traslato (fino a 180mm) che permette l'installazione senza modificare gli impianti di scarico esistenti.

This collection was designed to meet the need for smaller Sanitary ware. The contemporary guidelines, make it a product suitable for a young audience, open to innovation. BULL 500 Wc is available with the translated drain system (up to 180 mm) which allows installation without modifying the plumbing.

#BULL500
A TERRA





#Bianco Lucido

Lavabo Flat 1 Bianco Lucido / Flat 1 washbasin Bianco Lucido finish
Specchio touch-screen retro illuminato Led / Backlit Led mirror with touch ON/OFF sensor switch



Vaso Bull500 a terra Bianco Lucido / Bull500 BTW Wc Bianco Lucido finish
Copri vaso Bull500 soft-close a sgancio rapido Bianco Lucido / Soft close quick-release seat cover Bianco Lucido finish
Bidet Bull500 a terra Bianco Lucido / Bull500 BTW single hole bidet Bianco Lucido finish



#Bianco Lucido



Il piatto doccia ENIGMA è un piatto doccia termoformato rettangolare per installazione a filo pavimento, realizzato in Pietraluce nella finitura PANNA a tutto impasto. Il copri-scarico sempre in Pietraluce è ispezionabile e completo di sifone e piletta.

The ENIGMA shower tray is a thermoformed rectangular shower tray for floor-level installation, made of Pietraluce in PANNA full-body finish. The drain cover, in Pietraluce as well, can be inspected and includes siphon and drain.

#Panna Essence

BULL500



#BULL500
SOSPESA

#Bianco Lucido

BULL500

La consolle Revolution da 75 cm in ceramica, una vasca rettangolare con un angolo arrotondato e top laterale destro è un perfetto connubio tra design e funzionalità. Viene coordinata da moduli aggregativi in diverse misure (vedere l'area tecnica).

The 75 cm Revolution ceramic console. The rectangular bathtub with a rounded corner and a right side top. The perfect combination of design and functionality. All coordinated with auxiliary modules in different sizes (see technical area).



Consolle Revolution 75 Panna / Revolution 75 console Panna finish
Cassetto Revolution 30 Sabbia / Revolution 30 drawer Sabbia finish
Specchio touch-screen retro illuminato Led / Backlit Led mirror with touch ON/OFF sensor switch

#Sabbia Essence

Catalogo Generale



#Cotone Revolution

Lavabo FLAT 9 in Livin-Stone® Panna / FLAT 9 Livin-Stone® washbasin Cotone finish



#Cotone Revolution

Lavabo FLAT 8 in Livin-Stone® Panna / FLAT 8 Livin-Stone® washbasin Cotone finish



#Bianco Lucido

I sanitari sospesi della serie Bull500 in ceramica hanno dimensioni ridotte, forme essenziali e pulite che si adattano perfettamente a ogni spazio. Mettono in risalto ciò che è essenziale per donare una sobria eleganza. Ideali per il residenziale come per il contract.

The wall mounted version of the Bull500 ceramic series has: reduced dimension, essential and clean shapes to fit perfectly into any space. Ideal for residential as well as contract.



Vaso Bull500 sospeso Bianco Lucido / Bull500 wall-hung Wc Bianco Lucido finish
 Copri vaso Bull500 soft-close a sgancio rapido Bianco Lucido / Soft close quick-release seat cover Bianco Lucido finish
 Bidet Bull500 sospeso Bianco Lucido / Bull500 wall-hung single hole bidet Bianco Lucido finish

#Bianco Lucido



REVOLUTION SERIES

Cotone
pag. 92

Camelia
pag. 102

Aloe
pag. 112

Avio
pag. 124

PERCHÉ IL BAGNO DEVE ESSERE SOLO IN CERAMICA?

I PRIMI SANITARI IN (LIVIN-STONE®) SOLID SURFACE

Derivato dalla selezione di materie prime di primissima qualità, componente principale è una carica minerale naturale denominata, triidrato di alluminio (ATH), minerale derivato dalla Bauxite, legata da una bassa percentuale di materia "acrilata" che le conferisce malleabilità e lavorabilità. **È un materiale studiato per soddisfare i più alti standard di qualità tecnologia e impatto ambientale**, è:

VERSATILE: è un materiale ad alte prestazioni funzionali ed estetiche.

RAFFINATO: la superficie è solida (solid surface) omogenea, non porosa ed estremamente liscia. Oltre a trasmettere senso estetico e di purezza, è facile da pulire, non ingiallisce e il colore non perde tono nel tempo.

PREGIATO: è completamente atossico, antibatterico, inerte, ipoallergenico, ignifugo. E inoltre si può facilmente ripristinare, e riciclare rientrando così tra quei materiali definiti "eco-compatibili".

WHY SHOULD BATHROOM BE MADE ONLY OF CERAMIC?

THE FIRST SANITARY FIXTURES IN (LIVIN-STONE®) SOLID SURFACE

Derived from the selection of highest quality raw materials, the main component is a natural mineral filler called, aluminum tree-hydrate (ATH) derived from bauxite ore, linked by a low percentage of matter "acrylics" that gives malleability and workability. **It is a material designed to meet the highest standards of quality technology and environmental impact**, is:

VERSATILE: it is a material with high functional and aesthetic performance.

REFINED: the surface is solid (solid surface) homogeneous, non-porous and extremely smooth. Besides delivering aesthetic sense and purity, it is easy to clean, over time does not become yellow and does not lose the color tone.

QUALITY: is completely non-toxic, antibacterial, inert, hypoallergenic, flame retardant. And also you can easily recover, recycle and thus being part of those materials defined "environmentally friendly".



Design.

Spessori, angoli e linee unici
Superfici perfette senza irregolarità
Pulizia delle forme.

Sharpness, corners and unique lines
Perfect and regular surfaces
Cleaning of the shapes.



Il materiale scelto per realizzare la collezione REVOLUTION® dal design moderno è il Livin-Stone®, composto innovativo derivato principalmente da miscele di minerali, resine acriliche o poliestere e pigmenti. Caratteristica distintiva è la sua versatilità nella forma e nel suo impiego, è ideale sia per realizzare prodotti per il privato che per il contract. Si tratta di un materiale ad alte prestazioni funzionali ed estetiche, utilizzato per realizzare superfici piane e curve per arredamento e architettura, dal forte impatto visivo. Abbiamo dato libero sfogo all'immaginazione senza limiti strutturali. Il suo processo di lavorazione permette ai creativi SDR di impiegarlo anche nei sanitari.

Parola d'ordine **REVOLUTION®**.

The material chosen to create the modern design REVOLUTION® collection is Livin-Stone®, innovative compound derived mainly from mixtures of minerals, acrylic or polyester resins and pigments. Distinctive feature is its versatility in form and use, it is ideal for both private and contract products. It is a material with high functional and aesthetic performance, used to make flat surfaces and curves for furniture and architecture, with a strong visual impact. We have given free rein to the imagination without structural limits. Its manufacturing process allows SDR creatives to use it also in sanitary ware. Leading word **REVOLUTION®**.

REVOLUTION

Catalogo Generale

88

89



LIVIN-STONE®
ANTIBACTERIAL
MATERIAL

SANITARI ANTIBATTERICI

REVOLUTION®, il primo sanitario in Livin-Stone®, materiale durevole e facile da pulire e inoltre dotato di attività antibatterica. Conforme alla norma **ISO 22196:201 "MEASUREMENT OF ANTIBACTERIAL ACTIVITY ON PLASTIC AND OTHER NON-POROUS SURFACES"**. Questo rende Revolution®, già di per sé innovativo, ancora più all'avanguardia.

CURA E MANUTENZIONE QUOTIDIANA

Si consiglia di pulire la superficie utilizzando una spugna morbida con detergente anticalcare liquido e cremoso (Viacal®, Ajax®, Cif®) o anche uno sgrassatore. In generale, tutti gli sgrassatori universali sono adatti per la pulizia quotidiana delle superfici purché non contengano brillantanti, cere o altri componenti troppo aggressivi.

REVOLUTION®, the first toilet in Livin-Stone®, a durable and easy-to-clean material which also has antibacterial activity. Compliant with **ISO 22196:201 "MEASUREMENT OF ANTIBACTERIAL ACTIVITY ON PLASTIC AND OTHER NON-POROUS SURFACES"**. This makes Revolution®, already innovative by itself, even more avant-garde.

CARE AND DAILY MAINTENANCE

Si consiglia di pulire la superficie utilizzando una spugna morbida con detergente anticalcare liquido e cremoso (Viacal®, Ajax®, Cif®) o anche uno sgrassatore. In generale, tutti gli sgrassatori universali sono adatti per la pulizia quotidiana delle superfici purché non contengano brillantanti, cere o altri componenti troppo aggressivi.





ECO SOSTENIBILITÀ
ECO FRIENDLY

ESSERE GREEN



REVOLUTION® è ECO SOSTENIBILE. Il 75% del materiale del vaso e il 100% del materiale del bidet è riciclabile. Per produrre il vaso si risparmia il 70% di energia combustibile con relative emissioni in atmosfera in linea con il RISPETTO AMBIENTALE.

Il solid surface è un materiale avanzato composto da tri-idrato di alluminio e resina acrilica che uniscono resistenza e duttilità: questi materiali possono essere colorati, termoformati e assemblati unendo più elementi con giunte impercettibili, creando applicazioni di ogni dimensione piane o curve, con continuità di forma, che rimangono pressoché inalterate nel tempo. Grazie alla possibilità di aggiungere e combinare pigmenti colorati durante il processo produttivo (polimerizzazione), si possono ottenere moltissime sfumature diverse: il risultato sarà un prodotto esteticamente impeccabile e chimicamente stabile, con un impatto minimo sulla qualità dell'aria negli ambienti interni.

REVOLUTION® is ECO FRIENDLY. 75% of the material of the toilet and 100% of the material of the bidet is recyclable. To produce the toilet, 70% of fuel energy is saved with relative emissions into the atmosphere in relation to ENVIRONMENTAL RESPECT.

Solid surface is an advanced material composed of aluminum tri-hydrate and acrylic resin that combine strength and ductility: these materials can be colored, thermoformed and assembled by joining several elements with imperceptible joints, creating applications of any size, flat or curved, with continuity of shape, which remain almost unchanged over time.

Thanks to the possibility of adding and combining colored pigments during the production process (polymerization), many different shades can be obtained: the result will be an aesthetically flawless and chemically stable product with an impact minimum on indoor air quality.

RESISTANCE GUARANTEED



RESISTENTE
ECO FRIENDLY

Tutti i prodotti della collezione Revolution® hanno superato i test di carico statico, come da normativa Europea EN-997, questo significa che il vaso sospeso resiste ad un carico statico applicato di kg. 400 per 24 ore, proprio come un qualunque vaso sospeso in ceramica.

All the products of Revolution® collection passed the static load tests, as per European standard EN-997, this means that the suspended toilet resists an applied static load of kg. 400 for 24 hours, just like any ceramic suspended toilet.



C

#COTONE

Tutto è colore, anche il bianco. Nello spettro luminoso, il colore bianco comprende tutti gli altri. Evoca freschezza, pulizia, speranza, bontà, luce, purezza, minimalismo, perfezione perciò è spesso usato nell'arredamento domestico e del design. Con il bianco COTONE possiamo arredare la casa donando luce e ariosità agli ambienti domestici.

Everything is color, even white. In the light spectrum, white includes all others. It evokes freshness, cleanliness, hope, goodness, light, purity, minimalism, perfection so it is often used in home furnishings and design. With the COTONE white we can furnish the house giving light and airiness to domestic environments.

#REVOLUTION COTONE





Consolle Revolution 75 Bianco Lucido / Revolution 75 console Bianco Lucido finish
 Cassetto Revolution 90 Cotone / Revolution 90 drawer Cotone finish
 Specchio touch-screen retro illuminato Led / Backlit Led mirror with touch ON/OFF sensor switch



La stanza da bagno è un luogo di benessere, la tua spa personale. I mobili bagno dal design moderno sono la scelta ideale per chi vuole ispirarsi ai migliori centri wellness. Tutti i colori della linea REVOLUTION®, soprattutto il colore COTONE in Livin-Stone®, spicca per la sua finitura soft-touch nelle sue svariate forme, che siano consolle, lavabi o lavabi integrati nei mobili SOLIDO.

Bathroom is a place of well-being, your personal spa. Bathroom furniture with a modern design is the ideal choice for those who want to be inspired by the best wellness centers. All the colors of REVOLUTION® line, especially the COTONE color in Livin-Stone®, stands out for its soft-touch finish in its various forms, whether they are consoles, washbasins or washbasins integrated into SOLIDO furniture.

Mobile Solido cm 120x46 + top con vasca integrata sx / Solido Cabinet 120 cm + top with built-in washbasin on the left
 Specchio touch-screen retro illuminato Led / Backlit Led mirror with touch ON/OFF sensor switch

REVOLUTION

I sanitari sospesi REVOLUTION® con fissaggio nascosto consentono di non avere antiestetici fori di fissaggio a vista aumentando la pulizia delle forme, oltre a semplificare le operazioni di pulizia del pavimento.

REVOLUTION® wall-hung sanitary ware with hidden fixing doesn't have any visible fixing holes, increasing the cleanliness of the shapes, as well as simplifying cleaning operations of the floor.



Vaso Revolution sospeso Cotone / Wall-hung wc Cotone finish
 Copri vaso soft-close con cerniera a sgancio rapido / Soft close quick-release seat cover
 Bidet Revolution monoforo sospeso Cotone / Wall-hung single hole bidet Revolution Cotone finish
 Piletta click-clack universale e tappo in Livin-Stone® Cotone / Universal click-clack drain with Livin-Stone® Cotone finish cap

Catalogo Generale

Piatta doccia ENIGMA (Pietraluce) 90x130 cm / ENIGMA shower tray (Pietraluce) 90x130 cm



Sempre elegante ed essenziale, la vasca REVOLUTION® free-standing in Livin-Stone® si può posizionare al centro del bagno, se l'ambiente è ampio. In una stanza di dimensioni contenute, invece, la vasca è installabile anche vicino la parete, angolo o nicchia con il miscelatore incassato a parete.

Always elegant and essential, REVOLUTION® free-standing bathtub in Livin-Stone® is possible to place in the center of the bathroom, if the room is large. In a small room, on the other hand, the bathtub can also be installed near the wall, in a corner or in a niche with the built-in mixer on the wall.

C

#CAMELIA

Ormai per molti arredare rosa, arredare pink è diventata una mania, ma questo dimostra che il rosa sia tornato ad essere un colore protagonista è ormai una certezza, anche nell'arredamento! La passione per questo colore nella versione pastello, è di origine nordica, e ha invaso ogni elemento di design. Si tratta di un colore positivo che incute un certo senso di sicurezza e di ottimismo verso il futuro. Il rosa CAMELIA dà un tocco di eleganza e tranquillità agli ambienti riuscendo a creare locali dove ritemperarsi dalla caotica e frenetica vita moderna.

Nowadays for many, furnishing pink has become a craze, but this shows that pink has returned to be a leading color is now a certainty, even in furniture! The passion for this color in the pastel version is of Nordic origin, and has invaded every design element. It is a positive color that inspires a certain sense of security and optimism towards the future. CAMELIA pink gives a touch of elegance and tranquility to the rooms, managing to create places where you can recover from the chaotic and hectic modern life.

#REVOLUTION CAMELIA



REVOLUTION

Esaltare le forme per valorizzare gli spazi. Il miscelatore a muro con canna da 19 cm e piastra, come tutta la rubinetteria, è realizzato nel rispetto delle rigorose norme internazionali che prevedono l'utilizzo di materie prime di qualità superiore.

Enhance the forms to enhance the spaces. The wall mounted mixer with 19 cm spout and plate, like all the taps, is made in compliance with rigorous international standards which involve the use of superior quality raw materials.



Lavabo QUBE 10 in Livin-Stone® / QUBE 10 Livin-Stone® (Solid Surface) washbasin
Specchio touch-screen retro illuminato Led / Backlit Led mirror with touch ON/OFF sensor switch



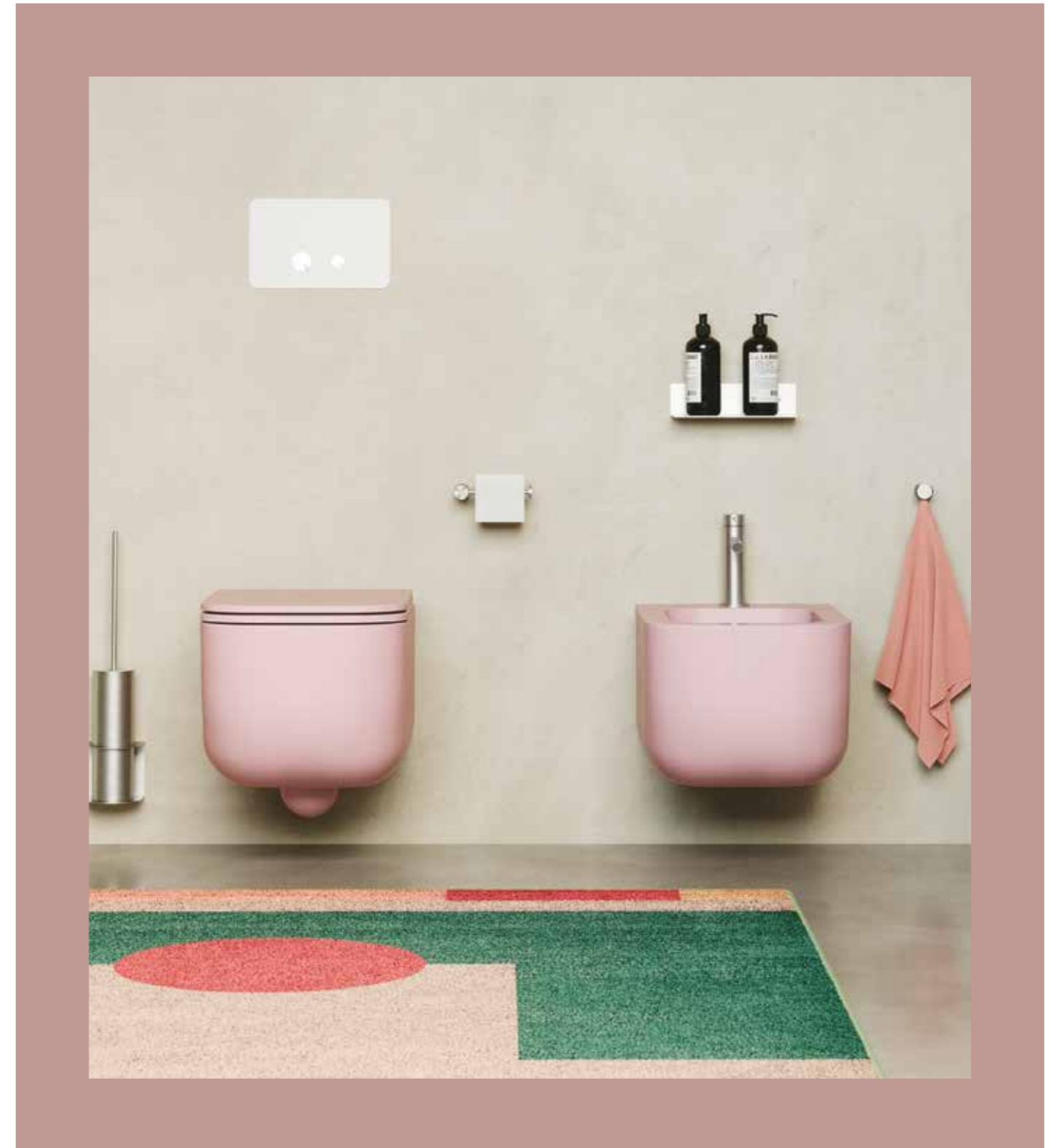

Vaso Revolution sospeso / Wall-hung wc Revolution
Coprivaso soft-close con cerniera a sgancio rapido / Soft close quick-release seat cover
Bidet Revolution monoforo sospeso / Wall-hung single hole bidet Revolution
Piletta click-clack universale e tappo in Livin-Stone® Cotone / Universal click-clack drain with Livin-Stone® Cotone finish cap



ENIGMA è un piatto doccia termoformato rettangolare per installazione sia in appoggio che a filo pavimento, nella finitura Camelia. Il copri-piletta nello stesso materiale è ispezionabile il tutto corredato da sifone e piletta.

ENIGMA is a rectangular thermoformed shower tray can be installed laid on or floor level, in Camelia finish. The drain cover in the same material can be inspected, all equipped with siphon and drain.

A

#ALOE

Il verde è per definizione il colore della natura e quindi di tutto ciò che è ecologico, che è bio, che non inquina, che è "green". Quindi per questi motivi ispira sensazioni pulite e rilassanti. Il verde nei bagni ricorda le atmosfere zen abbinato al candore del bianco.

Green is by definition the color of nature and therefore of everything that is ecological, that is organic, that does not pollute, that is "green". So for these reasons it inspires clean and relaxing sensations. The green in the bathrooms recalls the Zen atmosphere combined with the whiteness of white.

#REVOLUTION ALOE



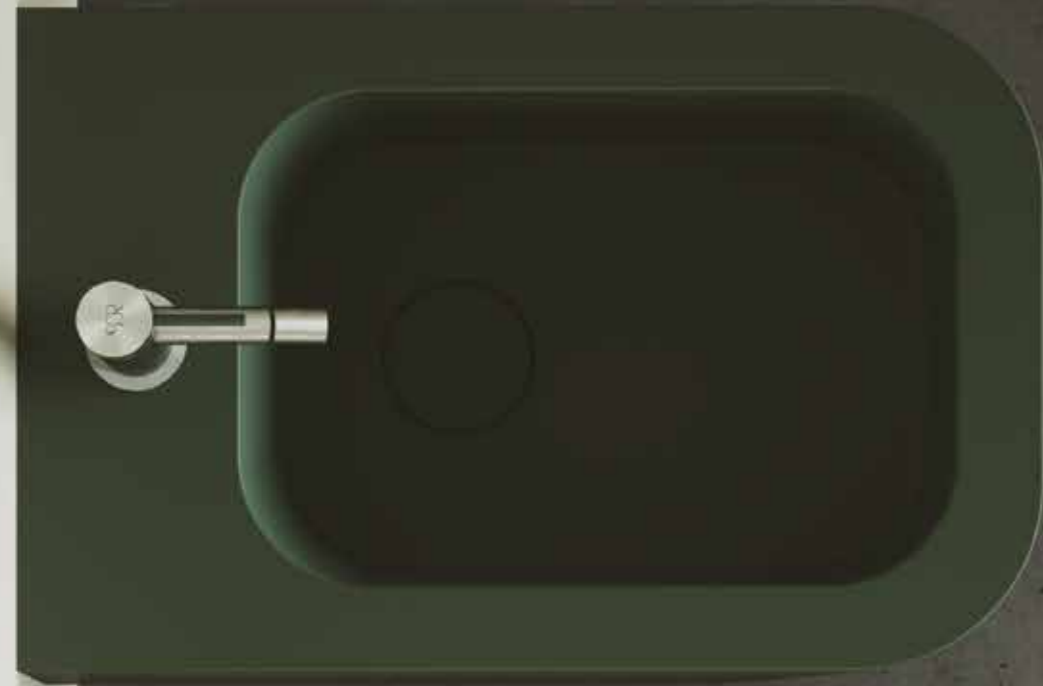

Vaso Revolution sospeso / Wall-hung wc Revolution
 Coprivaso soft-close con cerniera a sgancio rapido / Soft close quick-release seat cover
 Bidet Revolution monoforo sospeso / Wall-hung single hole bidet Revolution
 Piletta click-clack universale e tappo in Livin-Stone® Aloe / Universal click-clack drain with Livin-Stone® Aloe finish cap



Un colore l'Aloe, dalla finitura unica, inedita, risultato di un lavoro artigianale che porta risultati sempre ottimali. Gli angoli si fanno lineari, le forme e i volumi diventano protagonisti nell'ambiente bagno. È la materia che si deposita "morbidamente" su spigoli e superfici, omogenea e delicata espressione formale dalla forte personalità.

Aloe is a color, with a unique, unprecedented finish, the result of craftsmanship that always brings optimal results. The edges become linear, the shapes and volumes become protagonists in the bathroom environment. It is the material that settles "softly" on edges and surfaces, a homogeneous and delicate formal expression with a strong personality.



REVOLUTION



Lavabo monolitico QUBE 8 in Livin-Stone® / QUBE 8 Livin-Stone® free standing washbasin
 Piletta click-clack universale e tappo in Livin-Stone® Aloe /
 Universal click-clack drain with Livin-Stone® Aloe finish cap
 Specchio touch-screen retro illuminato Led / Backlit Led mirror with touch ON/OFF sensor switch

FASCIA COLORATA

La ricercatezza dei mobili SOLIDO, ma soprattutto la perfezione e la versatilità compositiva permettono di soddisfare il cliente finale con la vasta gamma di misure. New entry della linea REVOLUTION® sono le fasce colorate che impreziosiscono e rifiniscono elegantemente il design del mobile, evidenziando gli angoli arrotondati dei cassetti.

The refinement of SOLIDO furniture, but above all the perfection and compositional versatility allow to satisfy the final customer with the wide range of sizes. New entry of the REVOLUTION® line are the colored bands that embellish and elegantly finish the furniture design, highlighting the rounded corners of the drawers.

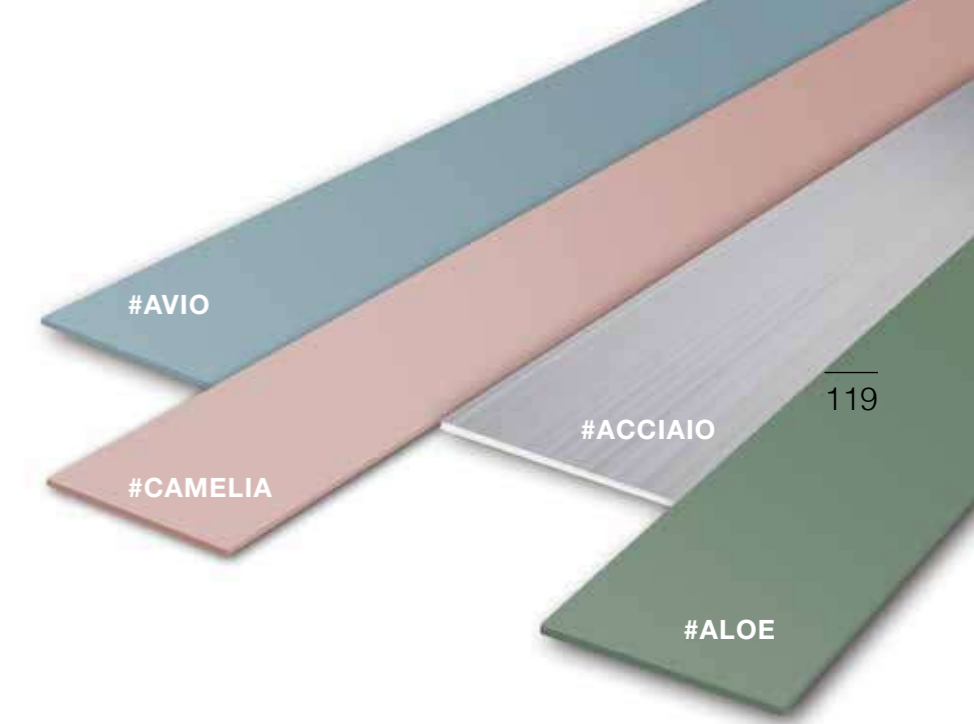



Mobile Solido cm 120 Aloe + Lavabo Qube 12 Aloe /
Solido Cabinet 120 Aloe finish + Qube 12 washbasin Aloe finish
Specchio touch-screen retro illuminato Led / Backlit Led mirror with touch ON/OFF sensor switch



Consolle Revolution 75 Cotone / Revolution 75 console Cotone finish
Cassetto Revolution 90 Aloe / Revolution 90 drawer Aloe finish
Specchio touch-screen retro illuminato Led / Backlit Led mirror with touch ON/OFF sensor switch



Vasca Revolution in Livin-Stone® / Revolution Livin-Stone® bath tube
Sifone e piletta di scarico con copripiletta / Plug cover + siphon



Piatto doccia ENIGMA 80x200 / ENIGMA shower tray 80x200
Sgabello Revolution in Livin-Stone® Cotone / Revolution stool Livin-Stone® Cotone finish



A

#AVIO

Arredare casa con il color Avio: eleganza e stile.

Un colore che ricorda le azulejos portoghesi e i tetti delle case bianche in Grecia, il color avio è una tonalità del blu che si intreccia alla perfezione con tanti stili e colori. Questo colore prende questo nome perché identifica quello delle uniformi militari dell'aviazione, appunto. Utilizzando il colore dei cieli nell'ambiente bagno lo rende delicato ed elegante.

Furnishing your home with Avio color: elegance and style.

A color reminiscent of Portuguese azulejos and the roofs of white houses in Greece, Avio is a shade of blue that intertwines perfectly with many styles and colors. This color takes this name because it identifies the color of the military aviation uniforms. Using the skies color in the bathroom makes it delicate and elegant.

#REVOLUTION AVIO





Lavabo monolitico QUBE 8 in Livin-Stone® Avio / QUBE 8 Livin-Stone® free standing washbasin
 Piletta click-clack universale e tappo in Livin-Stone® Avio /
 Universal click-clack drain with Livin-Stone® Avio finish cap

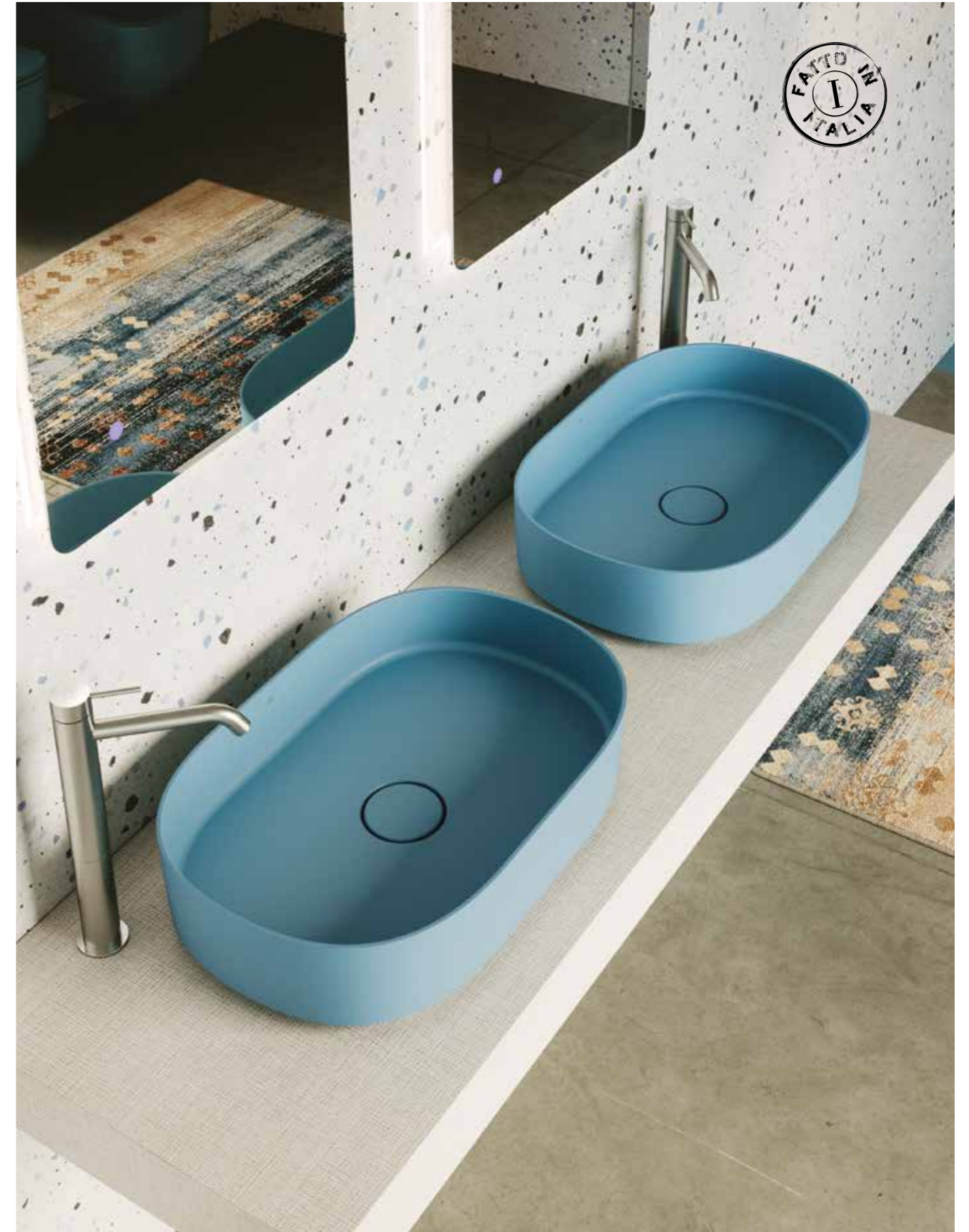

Lavabo FLAT 8 in Livin-Stone® / FLAT 8 Livin-Stone® washbasin
 Piletta click-clack universale e tappo in Livin-Stone® Avio / Universal click-clack drain with Livin-Stone® Avio finish cap



Vaso Revolution sospeso / Wall-hung wc Revolution
 Coprivaso soft-close con cerniera a sgancio rapido / Soft close quick-release seat cover
 Bidet Revolution monoforo sospeso / Wall-hung single hole bidet Revolution
 Piletta click-clack universale e tappo in Livin-Stone® Avio / Universal click-clack drain with Livin-Stone® Avio finish cap



ENIGMA è il piatto doccia rettangolare nell'esclusivo materiale e disponibile in una vasta gamma di misure. Questo materiale è brillante, impermeabile e con caratteristiche antibatteriche, resiste a tutti i prodotti liquidi usati per la pulizia. Inoltre può essere forato o tagliato con normali utensili d'acciaio. Elemento caratterizzante è la piletta grande ispezionabile che copre lo scarico dando una sensazione di perfetta uniformità.

ENIGMA is the rectangular shower tray in the exclusive material it is available in many different sizes. This material is shiny, waterproof and with antibacterial characteristics, it resists all liquid products used for cleaning. It can also be drilled or cut with normal steel tools. Characteristic element is the large inspectable drain that covers the drain giving a feeling of perfect uniformity.

Mobile Solido cm 90 Avio + Lavabo Qube 12 Avio / Solido Cabinet 120 Avio finish + Qube 12 washbasin Avio finish
Specchio touch-screen retro illuminato Led / Backlit Led mirror with touch ON/OFF sensor switch

Piatto doccia ENIGMA Avio (Pietraluce) 80x170 / ENIGMA shower tray Avio (Pietraluce) 80x170



LAVABI D'ARREDO WASHBASINS

Ceramica
pag. 136

Livin-Stone®
pag. 158

C

CERAMICA

Linee morbide che caratterizzano tante forme diverse per soddisfare le esigenze pratiche e caratterizzare la stanza da bagno. Nuovi materiali si aggiungono alla ceramica per creare nuove sensazioni e nuove ambientazioni. Le collezioni sono realizzate seguendo le tendenze più moderne. La ceramica raggiunge spessori mai realizzati prima, grazie al bordo da 5mm che gli conferisce una leggerezza unica.

Soft lines that mark out many different shapes to meet the practical requirements and characterize the bathroom. New materials are added to ceramic to create new sensations and new atmospheres. The collections are produced following the latest trends. Ceramic reaches sharpness never reached before, thanks to the 5 mm edge which gives it a unique lightness.

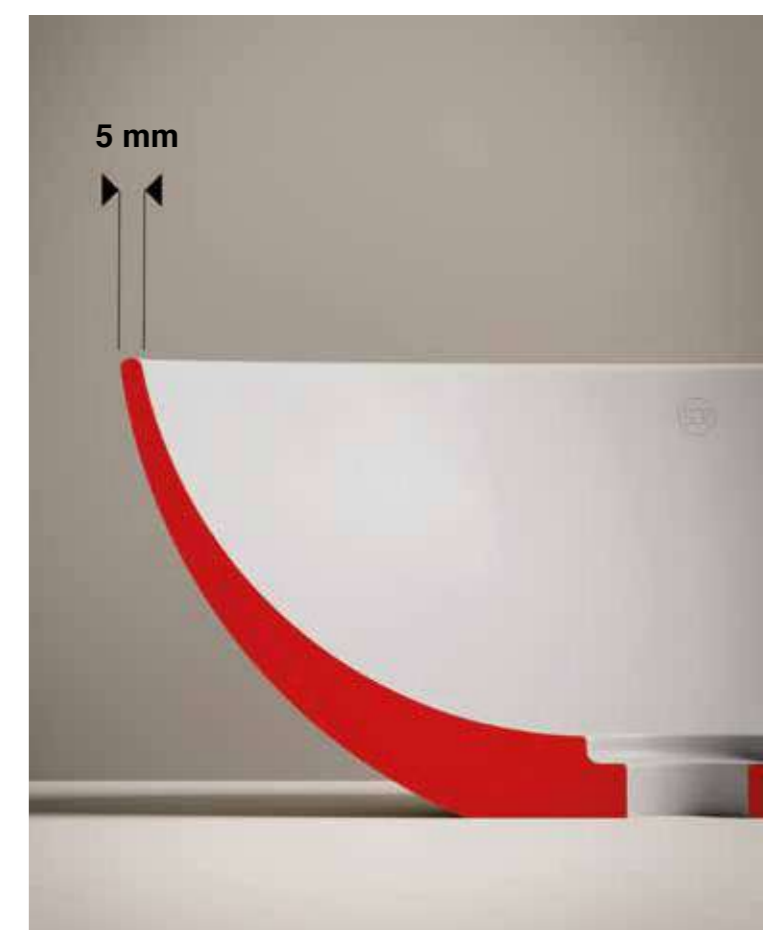

LAVABO POOL

Il nuovo lavabo d'appoggio dalla forma rettangolare Pool qui è proposto nel colore Verde NUANCE: essenziale e lineare è un arredo che sa valorizzare qualsiasi bagno. Si presenta con una semplice forma rettangolare con uno smusso alla base, ideale per chi cerca uno stile minimal per arredare il bagno.

POOL WASHBASIN

The new POOL rectangular countertop washbasin here is proposed in the Green NUANCE color: essential and linear is a furnishing piece that knows how to enhance any bathroom. It shows up with a simple rectangular shape with a bevel at the base, ideal for those looking for a minimal style to furnish the bathroom.



#Verde Nuance

#POOL 2

Lavabo Pool 2 Verde Nuance / Pool 2 washbasin Verde Nuance finish
Specchio touch-screen retro illuminato Led / Backlit Led mirror with touch ON/OFF sensor switch



#Grigio Nuance

#POOL 1

Lavabo POOL 1 GrigioNuance / POOL 1 washbasin Grigio Nuance finish
Specchio touch-screen retro illuminato Led / Backlit Led mirror with touch ON/OFF sensor switch



#Celeste Nuance

#LAKE 1

Lavabo Lake 1 Celeste Nuance / Lake 1 washbasin Celeste Nuance finish
Specchio touch-screen retro illuminato Led / Backlit Led mirror with touch ON/OFF sensor switch



#Rosa Nuance

LAVABO LAKE

Non un semplice lavabo da bagno, ma vero e proprio elemento di arredo è il lavabo LAKE dalla forma tondeggiante e con uno smusso delicato alla base. Esalta il tuo bagno attraverso forme innovative e la nota di colore leggermente rosata renderà più giovane e vivace il tuo ambiente bagno!

LAKE WASHBASIN

Is not a simple bathroom sink, but a real furnishing element. Round shape and with a delicate bevel at the base. Enhances your bathroom through Innovative shapes and the note of slightly pink color will make your bathroom young and lively.

#LAKE 2

Lavabo Lake 2 Rosa Nuance / POOL 1 washbasin Rosa Nuance finish
Specchio touch-screen retro illuminato Led / Backlit Led mirror with touch ON/OFF sensor switch

#Bianco Lucido



#FLAT 1

Lavabo Flat 1 Bianco Lucido / Flat 1 washbasin Bianco Lucido finish
Specchio touch-screen retro illuminato Led / Backlit Led mirror with touch ON/OFF sensor switch

#Grafite Essence



#FLAT 2

Lavabo Flat 2 Grafite / Flat 2 washbasin Grafite finish
Specchio touch-screen retro illuminato Led / Backlit Led mirror with touch ON/OFF sensor switch



#Magnesio Essence

#FLAT 3

Lavabo Flat 3 Magnesio / Flat 3 washbasin Magnesio finish
Specchio touch-screen retro illuminato Led / Backlit Led mirror with touch ON/OFF sensor switch



#Panna Essence

#FLAT 4

Lavabo Flat 4 Panna / Flat 3 washbasin Panna finish
Specchio touch-screen retro illuminato Led / Backlit Led mirror with touch ON/OFF sensor switch



#FLAT 5

Lavabi monolitici Flat 5 Beige Nuance /
Flat 5 free standing washbasin Beige Nuance finish

Specchi touch-screen retro illuminati Led /
Backlit Led mirrors with touch ON/OFF sensor switch

#Beige Nuance





#Grafite Essence

#QUBE 1

Lavabo Qube 1 Grafite / Qube 1 washbasin Grafite finish
Specchio touch-screen retro illuminato Led / Backlit Led mirror with touch ON/OFF sensor switch

#Ghiaccio Essence

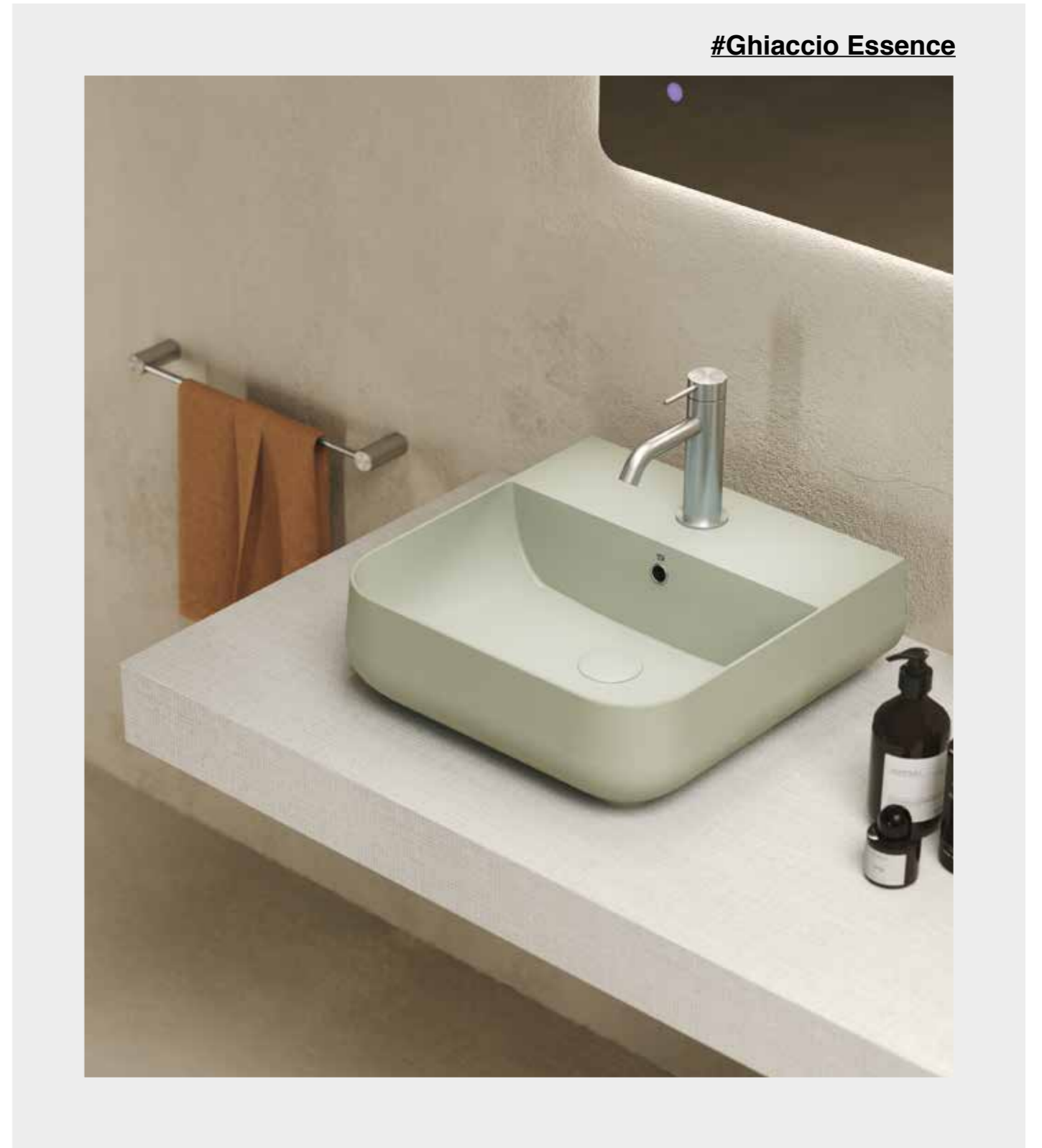

#QUBE 2

Lavabo Qube 2 Ghiaccio / Qube 2 washbasin Ghiaccio finish
Specchio touch-screen retro illuminato Led / Backlit Led mirror with touch ON/OFF sensor switch



#Rosa Nuance

#QUBE 3

Lavabo Qube 3 Rosa Nuance / Qube 3 washbasin Rosa Nuance finish
Specchio touch-screen retro illuminato Led / Backlit Led mirror with touch ON/OFF sensor switch



#Caffè Essence

#POOL 3

Lavabo Pool 3 Caffè / Pool 3 washbasin Caffè finish
Specchio touch-screen retro illuminato Led / Backlit Led mirror with touch ON/OFF sensor switch



#Sabbia Essence

#POOL 4

Lavabo Pool 4 Sabbia / Pool 4 washbasin Sabbia finish
Specchio touch-screen retro illuminato Led / Backlit Led mirror with touch ON/OFF sensor switch



#Verde Nuance

#POOL 5

Lavabo Pool 5 Verde Nuance / Pool 5 washbasin Verde Nuance finish
Specchio touch-screen retro illuminato Led / Backlit Led mirror with touch ON/OFF sensor switch



#Beige Nuance

#QUBE 5

Lavabo Qube 5 Beige Nuance / Qube 5 washbasin Beige Nuance finish
Specchio touch-screen retro illuminato Led / Backlit Led mirror with touch ON/OFF sensor switch



#Bianco Lucido

#QUBE11

Lavabo QUBE 11 Bianco Lucido / QUBE 11 washbasin Bianco Lucido finish
Specchio touch-screen retro illuminato Led / Backlit Led mirror with touch ON/OFF sensor switch

LAVABI D'ARREDO REVOLUTION

CONSOLE REVOLUTION

La nuova consolle Revolution in ceramica disponibile in due misure (75 e 95 cm). È una vasca rettangolare con un angolo arrotondato e top laterale destro, un perfetto connubio tra design e funzionalità.

REVOLUTION CONSOLE

The new ceramic Revolution console available in two sizes (75 and 95 cm). It is a rectangular basin with a rounded corner and a right side top, a perfect combination of design and functionality.



#Cotone Revolution

#REVOLUTION 75

Consolle Revolution 75 Cotone / Revolution 75 console Cotone finish
Cassetto Revolution 30 Camelia / Revolution 30 drawer Camelia finish
Specchio touch-screen retro illuminato Led / Backlit Led mirror with touch ON/OFF sensor switch



#Bianco Lucido

#REVOLUTION 95

Consolle Revolution 95 Bianco Lucido / Revolution 95 console Bianco Lucido finish
Cassetto Revolution 60 Avio / Revolution 60 drawer Avio finish
Specchio touch-screen retro illuminato Led / Backlit Led mirror with touch ON/OFF sensor switch



LIVIN-STONE®

Derivato dalla selezione di materie prime di primissima qualità, componente principale è una carica minerale naturale denominata, tri-idrato di alluminio (ATH), minerale derivato dalla Bauxite, legata da una bassa percentuale di materia "acrilata" che le conferisce malleabilità e lavorabilità è un materiale studiato per soddisfare i più alti standard di qualità tecnologia e impatto ambientale, è:

VERSATILE: è un materiale ad alte prestazioni funzionali ed estetiche.

RAFFINATO: la superficie è solida (solid surface) omogenea, non porosa ed estremamente liscia. Oltre a trasmettere senso estetico e purezza, è facile da pulire, non ingiallisce e il colore non perde tono nel tempo.

PREGIATO: è completamente atossico, inerte, ipoallergenico, ignifugo.

E inoltre si può facilmente ripristinare, e riciclare rientrando così tra quei materiali definiti "eco-compatibili".

DINAMICO: il colore è in tutta pasta e non semplicemente verniciato.

Derived from the selection of highest quality raw materials, the main component is a natural mineral filler called aluminum tri-hydrate (ATH) issued from bauxite, alloyed by a low percentage of "acrylic" matter that gives malleability and workability) a material designed to meet the highest standards of quality, technology and environmental impact that is:

VERSATILE: it is a material with high functional and aesthetic performance.

REFINED: the surface is solid (solid surface) homogeneous, non-porous and extremely smooth.

Besides delivering aesthetic sense and purity, it is easy to clean, over time does not become yellow and does not lose the color tone.

QUALITY: it is completely non-toxic, antibacterial, inert, hypoallergenic and fireproof. Easily restorable and recyclable, it can therefore be defined as "eco-friendly".

DYNAMIC: the color is full body and not simply painted.

#Cotone Revolution



#FLAT 7

Lavabo Flat 7 in Livin-Stone® Cotone / Flat 7 Livin-Stone® washbasin Cotone finish
Specchio touch-screen retro illuminato Led / Backlit Led mirror with touch ON/OFF sensor switch

#Aloe Revolution

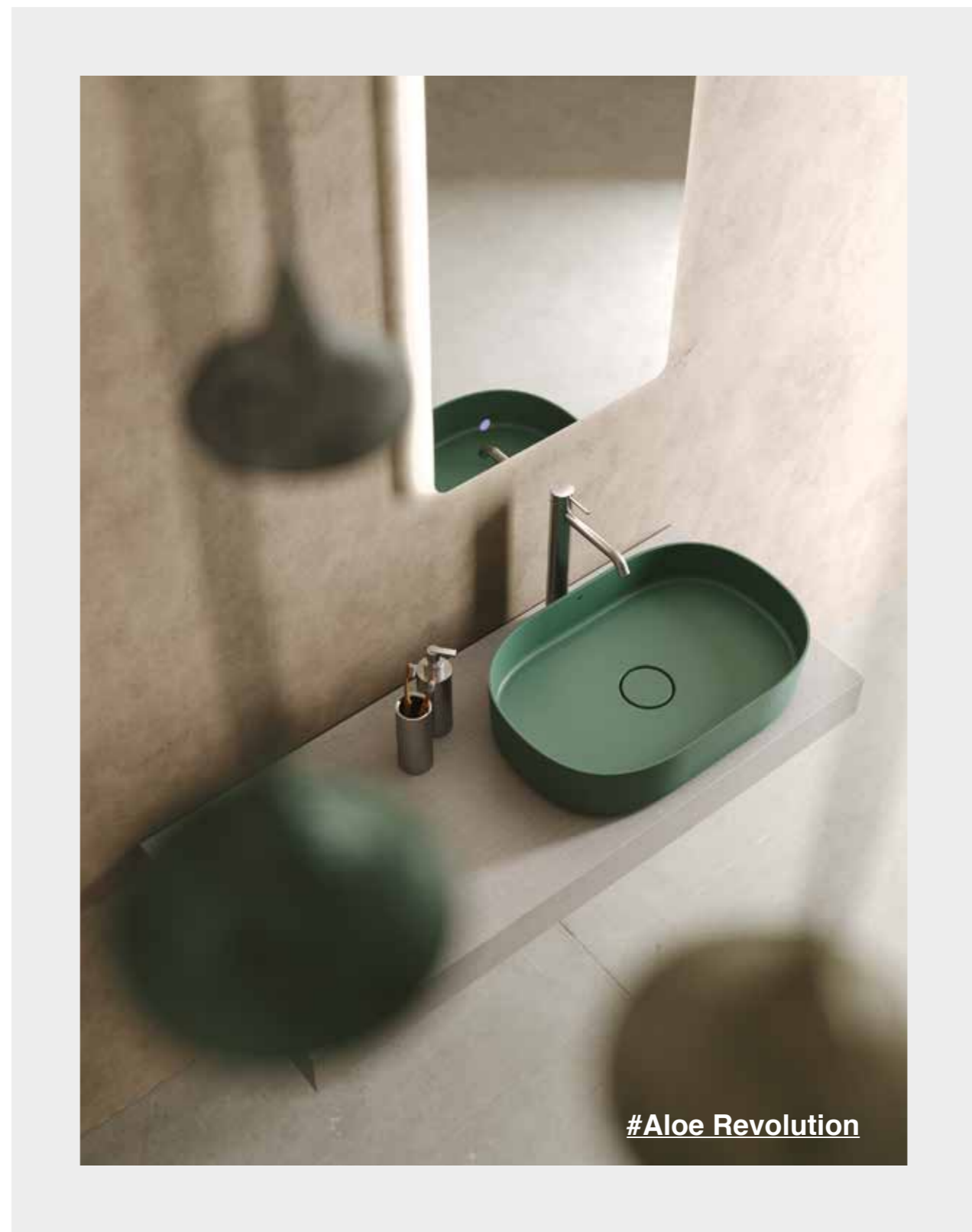

#FLAT 8

Lavabo Flat 8 in Livin-Stone® Aloe / Flat 8 Livin-Stone® washbasin Aloe finish
Specchio touch-screen retro illuminato Led / Backlit Led mirror with touch ON/OFF sensor switch



#Camelia Revolution

#FLAT 9

Lavabo Flat 9 in Livin-Stone® Camelia / Flat 9 Livin-Stone® washbasin Camelia finish
Specchio touch-screen retro illuminato Led / Backlit Led mirror with touch ON/OFF sensor switch



#Avio Revolution

#QUBE 8

Lavabo monolitico Qube 8 in Livin-Stone® Avio / Qube 8 Livin-Stone® free standing washbasin
Piletta click-clack universale e tappo in Livin-Stone® Avio / Universal click-clack drain with Livin-Stone® Avio finish cap
Specchio touch-screen retro illuminato Led / Backlit Led mirror with touch ON/OFF sensor switch



#Beige Nuance

#FLAT 6

Lavabo monolitico Flat 6 in Livin-Stone® Beige Nuance / Flat 6 Livin-Stone® free standing washbasin Beige Nuance finish
 Piletta click-clack universale e tappo in Livin-Stone® Beige Nuance / Universal click-clack drain with Livin-Stone® Beige Nuance finish cap
 Specchio touch-screen retro illuminato Led / Backlit Led mirror with touch ON/OFF sensor switch



#Panna Essence

#QUBE 7

Lavabo monolitico Qube 7 in Livin-Stone® Panna / QUBE 7 Livin-Stone® free standing washbasin Panna finish
 Piletta click-clack universale e tappo in Livin-Stone® Panna / Universal click-clack drain with Livin-Stone® Panna finish cap
 Specchio touch-screen retro illuminato Led / Backlit Led mirror with touch ON/OFF sensor switch



#Cotone Revolution

#QUBE 9

Lavabo Qube 9 in Livin-Stone® Cotone / Qube 9 Livin-Stone® free standing washbasin Cotone finish
Specchio touch-screen retro illuminato Led / Backlit Led mirror with touch ON/OFF sensor switch



#Aloe Revolution

#QUBE 10

Lavabo Qube 10 in Livin-Stone® Aloe / Qube 10 Livin-Stone® washbasin Aloe finish
Specchio touch-screen retro illuminato Led / Backlit Led mirror with touch ON/OFF sensor switch

#TOP SOLIDO 120 CON VASCA INTEGRATA SX

Mobile Solido cm 120x46 Panna + top con vasca integrata sx /
Solido Cabinet 120 cm Panna finish + top with built-in washbasin on the left

Specchio touch-screen retro illuminato Led /
Backlit Led mirror with touch ON/OFF sensor switch



Il lavabo SOLIDO in Livin-Stone® può essere posizionato a destra o a sinistra oppure su entrambi i lati, ottenendo un doppio lavabo molto funzionale. Le misure disponibili sono 70, 90, 120, 140 e 160 cm fino ad arrivare a 200 cm (SU MISURA). Per ordinare misure fuori standard fare riferimento al listino prezzi.

The SOLIDO washbasin in Livin-Stone® can be placed on the right or left or on both sides, obtaining a very functional double washbasin. Available sizes are 70, 90, 120, 140 and 160 cm up to 200 cm (CUSTOM-MADE). To order off-standard sizes, refer to the price list.

#Panna Essence



**VASCHE
LIVIN-STONE®
BATH-TUBS**

Bull
pag. 172

Quadra
pag. 174

Revolution Ovale
pag. 176

Revolution Quadra
pag. 177

Le vasche freestanding in Livin-Stone® nei modelli BULL e QUADRA sono ideate da SDR per essere protagoniste dell'ambiente bagno. Sono realizzate con materie prime di altissima qualità garantendo quindi un'eccellente durata nel tempo ed una facile pulizia.

The Livin-Stone® freestanding bathtubs of the lines BULL and QUADRA are designed by SDR to be protagonists of the bathroom environment. They are produced with the highest quality raw materials guaranteeing excellent durability and easy cleaning.



#Beige Nuance

#VASCA BULL

Vasca Bull in Livin-Stone® Beige Nuance / Bull bathtub in Livin-Stone® Beige Nuance finish

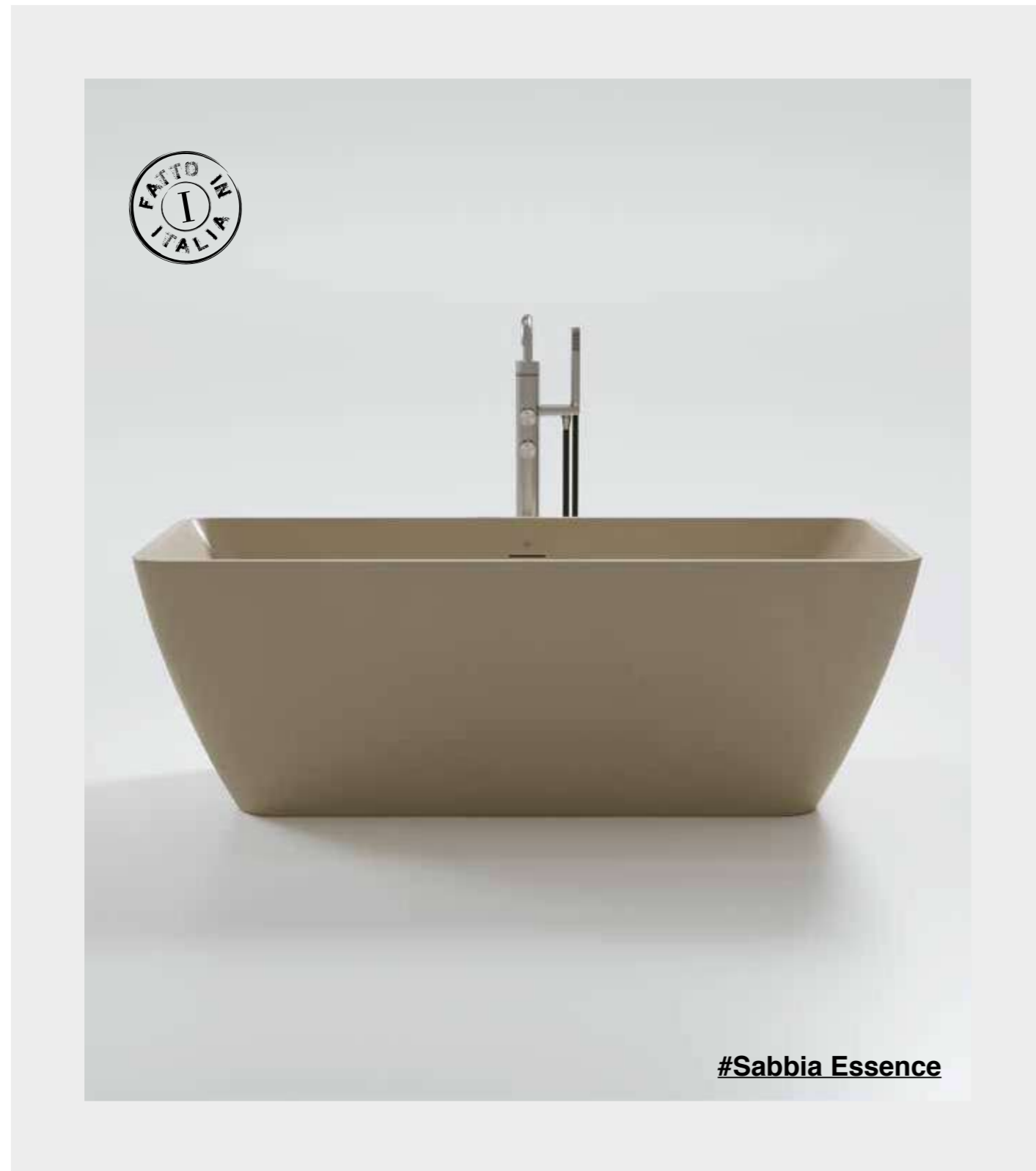

#VASCA QUADRA

Vasca Quadra in Livin-Stone® Sabbia / Quadra bathtub in Livin-Stone® Sabbia finish



#Panna Essence



[#Camelia Revolution](#)

#VASCA REVOLUTION OVALE

Vasca Ovale Revolution in Livin-Stone® Camelia / Oval Revolution Livin-Stone® bathtub Camelia finish
Sgabello Revolution in Livin-Stone® Camelia / Revolution stool Cotone Livin-Stone® Camelia finish



[#Avio Revolution](#)

#VASCA REVOLUTION QUADRA

Vasca Quadra Revolution in Livin-Stone® Avio / Quadra Revolution Livin-Stone® bath tube Avio finish

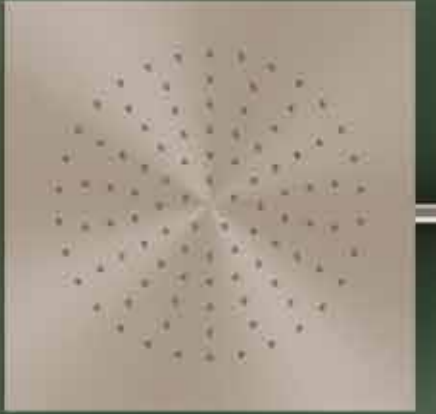
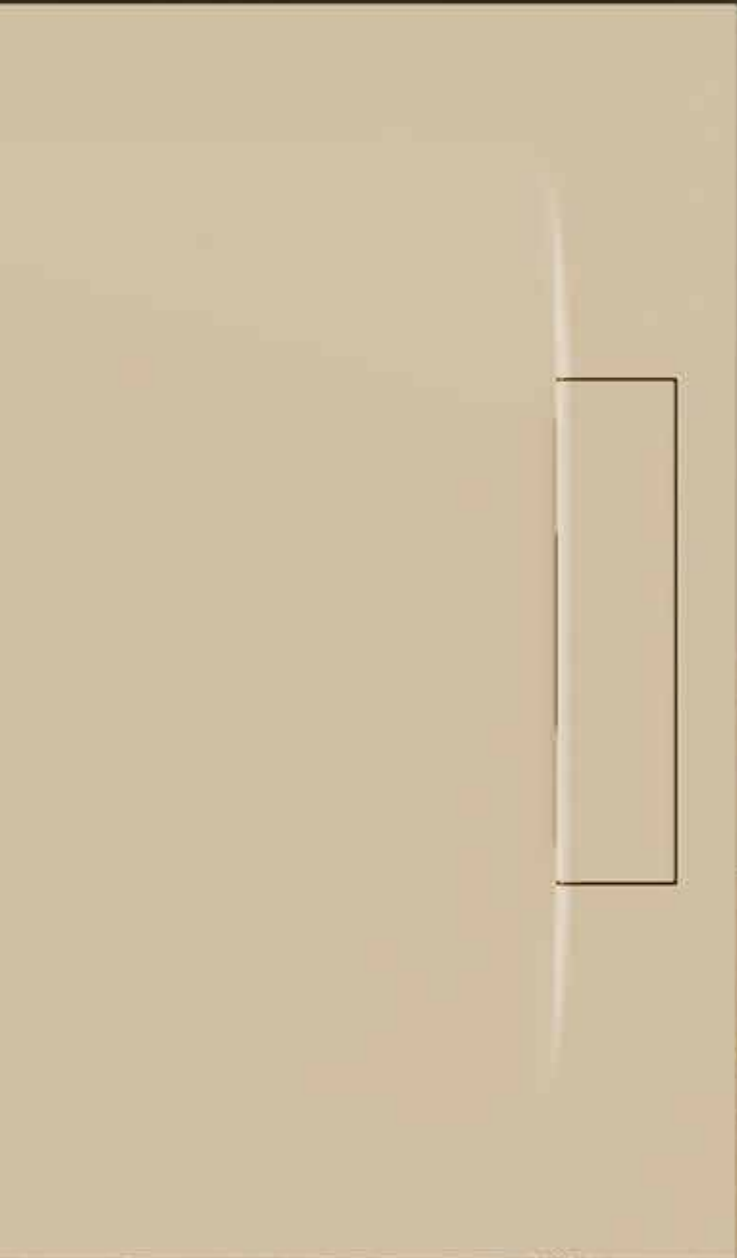

**PIATTI
DOCCIA**
SHOWER TRAYS

Long Life
pag. 186

Enigma
pag. 202

180

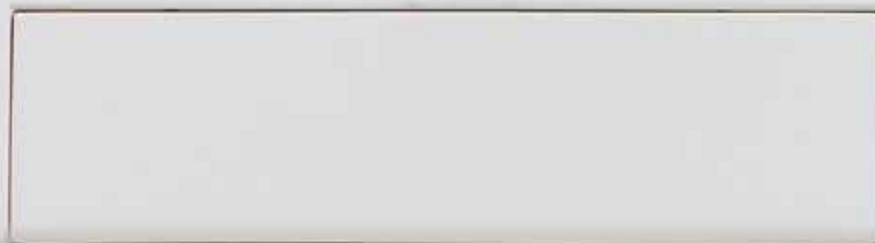

ENIGMA
(PietraLuce)

LONG LIFE
(Ceramica)



181

COLLEZIONE **PIATTI DOCCIA**

Shower tray collection

I piatti doccia SDR uniscono materiali di alta qualità, design lineare e caratteristiche tecniche innovative. Inoltre offrono facilità d'installazione, di pulizia e di manutenzione, in modo da soddisfare tutte le possibili esigenze.

Proprio per questo motivo abbiamo cercato di unificare l'aspetto estetico, per cui rimangono invariati: piletta sifonata di ultima generazione e copripiletta, altezza 3 cm, quello che varia è il materiale. Siamo riusciti a far convivere perfettamente materiali di natura diversa nello stesso impianto del piatto doccia.

SDR shower trays combine high quality materials, linear design and innovative technical features. they also offer ease of installation, cleaning and maintenance, in order to satisfy all possible needs.

It is for this reason that we have tried to unify the aesthetic aspect: latest generation drain and drain cover, height 3 cm... the only difference is the material.

we have managed to make materials of different nature perfectly coexist in the same design of the shower tray.



SPESSORE RIDOTTO
REDUCED THICKNESS

H 3 cm.

L'innovazione dell'eleganza e la leggerezza dello spessore ridotto di tutta la nostra gamma dei piatti doccia.

The innovation of elegance and lightness of the reduced thickness of our entire range of shower trays.



La rivoluzionaria tecnologia sviluppata negli stabilimenti SDR consente di ottenere una qualità d'eccellenza e una cura dei dettagli eccezionale, conferendo ai piatti doccia un design dall'aspetto ultramoderno. Dalla combinazione tra i materiali (ceramica, pietraluce e marmoresina) e know-how d'avanguardia si ottiene un **prodotto finale dalle elevate prestazioni sia tecniche che estetiche**, proiettando così **l'intera gamma SDR al massimo livello**.

The revolutionary technology developed in SDR factories allows for excellent quality and exceptional attention to detail, giving the shower trays an ultra-modern design. From the combination of materials (Ceramic, Pietraluce and Marble Resin) and know-how, to obtain **a final product with high technical and aesthetic performance**, thus projecting **the entire SDR range at the highest level**.



PILETTA RETTANGOLARE
RECTANGULAR DRAIN

Piletta & Copripiletta.

Drain and drain cover

La piletta rettangolare ispezionabile con coperchio ultrapiatto integra e rafforza le caratteristiche di unicità dei piatti doccia Long Life e Enigma.

Rectangular drain that can be inspected and ultra-flat lid integrates and strengthens the unique characteristics of Long Life and Enigma shower trays.

Entrambe le tipologie di piatti doccia SDR sono caratterizzati da una pendenza per il deflusso veloce dell'acqua e sono completi di piletta sifonata di ultima generazione che ha una portata di scarico acqua di 60 lt al minuto e copripiletta in tono con il colore del piatto doccia scelto. Massima ispezionabilità grazie alle due vaschette e allo **speciale filtro ferma-capelli**.

Both of types of SDR shower trays are characterized by a slope for the fast flow of water and they are complete with the latest generation siphon drain which has a water discharge rate of 60 liters per minute, and matching color with the shower drain cover. Maximum inspection thanks to the two small trays and the **special hair filter**.



CERTIFICAZIONI



LONG LIFE

Certificato con trattamento
antiscivolo opzionale

*Certified with treatment
non-slip optional*



LONG LIFE

I Piatti doccia in ceramica LONG LIFE di soli 3cm di altezza sono sviluppati e realizzati negli stabilimenti SDR dove la qualità delle materie prime la fa da padrone.

La piletta a scomparsa conferisce al prodotto un design dall'aspetto ultramoderno. Perfetta è la planarità del piatto combinata alla leggerezza può essere installato sia a filo pavimento che in appoggio. È disponibile nelle 34 misure e in tutte le colorazioni ceramiche.

LONG LIFE ceramic shower trays only 3cm high is developed and made in SDR factories where the quality of the materials is premium.

The concealed drain gives the product an attractive design ultramodern. The flatness of the plate is perfect combined with lightness it can be installed floor level or laid on. It's available in 34 sizes and in all the ceramic colors

#CERAMICA

Piatti doccia in ceramica che rivoluzionano l'ambiente bagno in un vero e proprio spazio dove estetica e funzionalità si sposano in modo armonico.

Ceramic shower trays that revolutionize the bathroom in a space where aesthetics and functionality harmoniously coexist.



Mobile Solido cm 120x46 Beige Nuance + top con vasca integrata sx /
Solido Cabinet 120 cm Beige Nuance finish + top with built-in washbasin on the left
Specchio touch-screen retro illuminato Led / Backlit Led mirror with touch ON/OFF sensor switch

Piatto doccia LONG LIFE 70x160 Beige Nuance /
LONG LIFE shower tray Beige Nuance 70x160

#Beige Nuance

SHOWER TRAYS

190

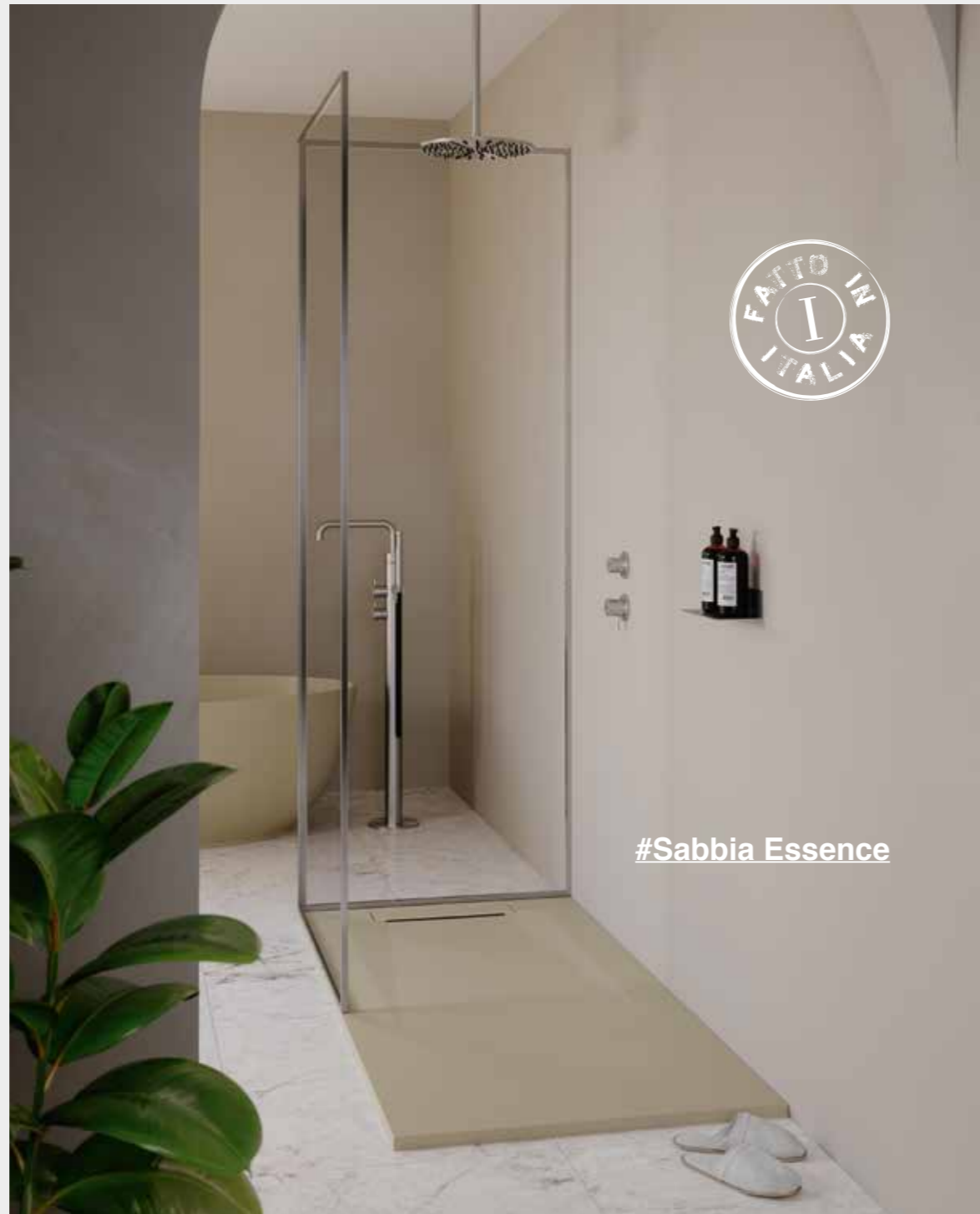

#Sabbia Essence

#LONG LIFE

Piatto doccia LONG LIFE 70x140 Sabbia / LONG LIFE shower tray 70x140 Sabbia finish

Catalogo Generale

191



#LONG LIFE

Piatto doccia LONG LIFE 80x125 Bianco Lucido /
LONG LIFE shower tray 80x125 Bianco Lucido finish

#Bianco Lucido

Uno dei vantaggi nell'installare il piatto doccia a filo pavimento è quello di avere un piano di appoggio allo stesso livello del pavimento: niente scalini, rialzi o sporgenze. Il piatto è incassato nel massetto di sottofondo. Si ha quindi una soluzione dove il minor ingombro visivo inganna l'occhio per far apparire più grande la stanza.

One of the advantages of installing the tray floor level shower is to have a totally even surface at the same level of the floor: no steps, risers or protrusions. The tray is recessed in the background screed. We therefore have one solution where the smallest visual footprint tricks the eye to make the room appear bigger.



#LONG LIFE

Piatto doccia LONG LIFE 70x175 Beige Nuance /
LONG LIFE shower tray 70x175 Beige Nuance finish

#Beige Nuance

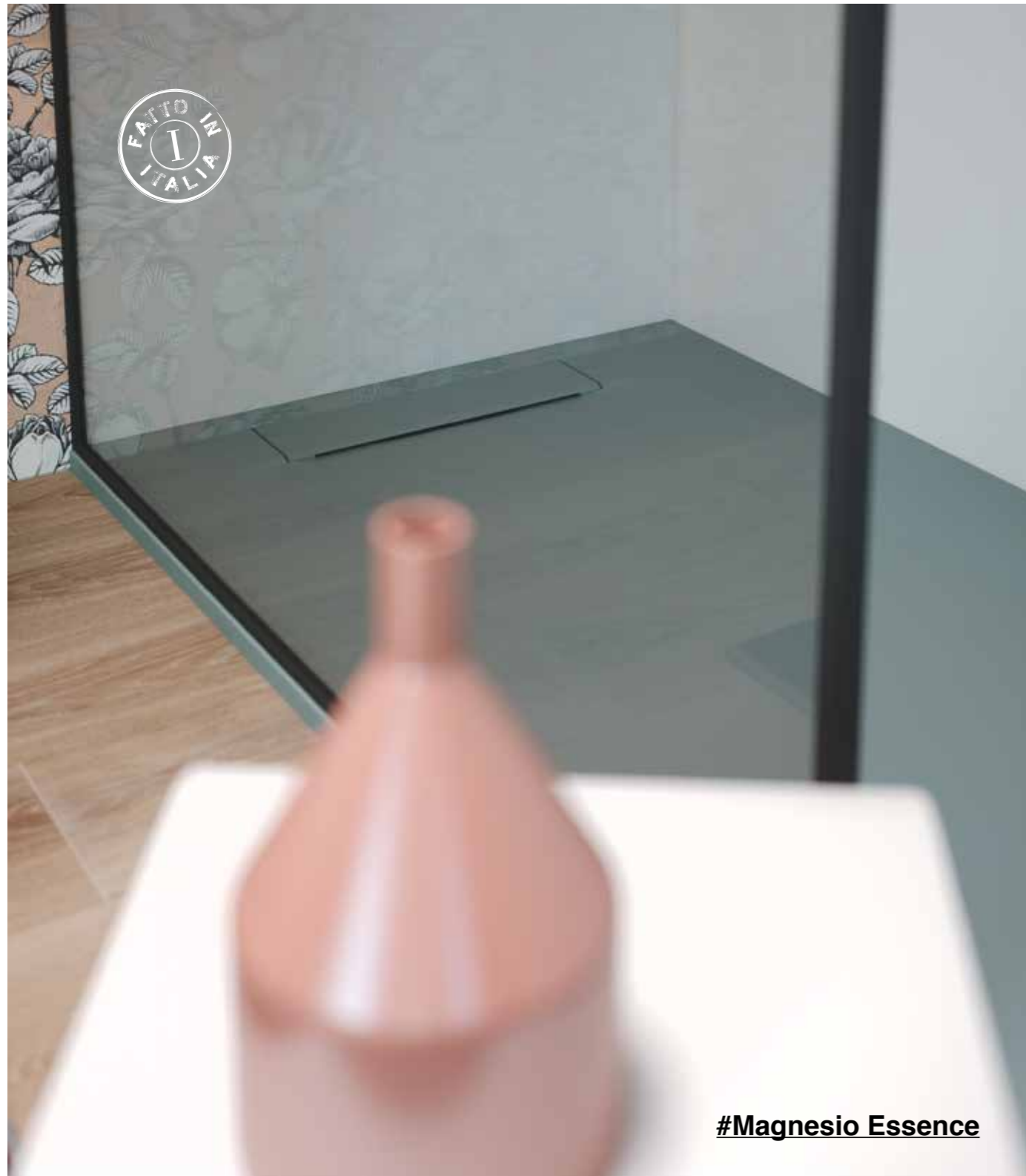

#Magnesio Essence

#LONG LIFE

Piatto doccia LONG LIFE H3 80x180 Magnesio / LONG LIFE H3 shower tray 80x180 Magnesio finish



#LONG LIFE

Piatto doccia LONG LIFE 70x160 Verde Nuance /
LONG LIFE shower tray 70x160 Verde Nuance finish

#Verde Nuance

#LONG LIFE

Piatto doccia LONG LIFE 80x140 Grafite /
LONG LIFE shower tray 80x140 Grafite finish

Lavabo Pool 1 Grafite / Pool 1 washbasin Grafite finish
Specchio touch-screen retro illuminato Led / Backlit Led mirror with touch ON/OFF sensor switch
Sgabello in Livin-Stone® Panna / Stool Livin-Stone® Panna finish

#Grafite Essence

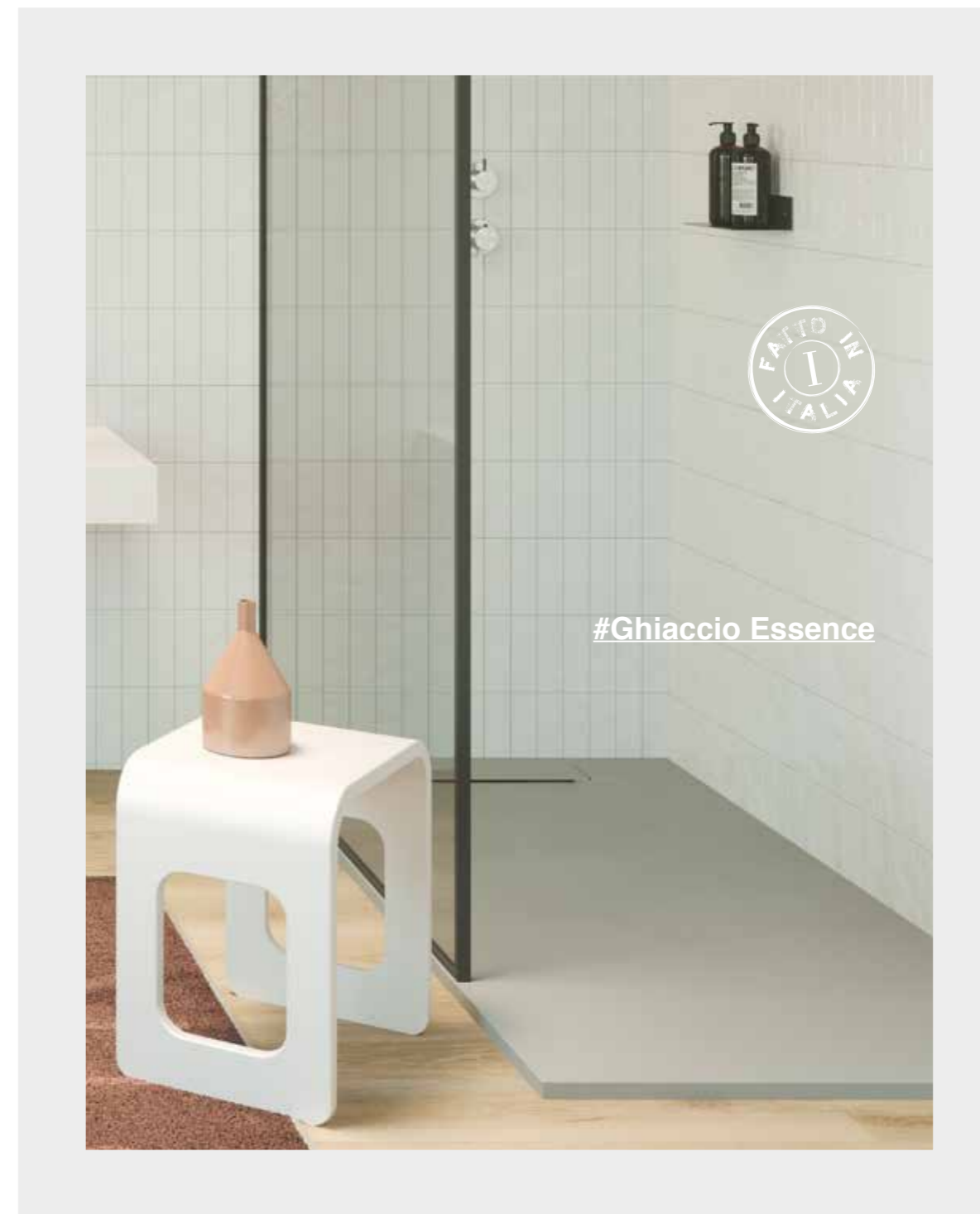

#Ghiaccio Essence

#LONG LIFE

Piatto doccia LONG LIFE 80x150 Ghiaccio /
LONG LIFE shower tray 80x150 Ghiaccio finish

Sgabello in Livin-Stone® Panna / Stool Livin-Stone® Panna finish

Kit Antiscivolo per piatto doccia Long Life.

Long Life shower tray anti-slip kit



Kit antiscivolo per piatti doccia **LONG LIFE**
LONG LIFE shower trays anti-slip kit
Cod. **KALL**

SDR propone (a richiesta) a tutti i suoi clienti che scelgono il piatto doccia in ceramica Long Life un prodotto antiscivolo rivoluzionario.

SDR offers (on request) all its customers who choose **LONG LIFE** ceramic shower tray a revolutionary non-slip product.

Il nostro KIT ANTISCIVOLO permette di intervenire in modo naturale e non aggressivo sulla superficie in ceramica rendendola antiscivolo e facile da pulire, assicurando performance di attrito superiori ai parametri richiesti dalle leggi vigenti. **Il trattamento può essere eseguito direttamente in azienda** (se richiesto dal cliente) o può essere applicato direttamente dall'utente finale grazie all'apposito kit (cod. KALL).

Our anti-slip kit allows you to intervene in a natural and non-aggressive way on the ceramic surface, making it anti-slip and easy to clean, ensuring friction performance exceeding the required parameters. **The treatment can be applied directly in the company (if requested by the customer) or can be applied directly by the end user**, using to apposite kit (cod. KALL).



I PLUS DEL NOSTRO RIVOLUZIONARIO TRATTAMENTO ANTISCIVOLO DI NUOVA GENERAZIONE

- TRATTAMENTO IN NANOTECNOLOGIA
- NON INVASIVO
- NO MANUTENZIONE
- DURATA PERMANENTE
- CERTIFICAZIONE ANTISCIVOLO

PLUS OF THE ANTI-SLIP

- NANOTECHNOLOGY TREATMENT
- NO INVASIVE
- NO MAINTENANCE
- PERMANENT DURATION
- ANTI-SLIP CERTIFICATION

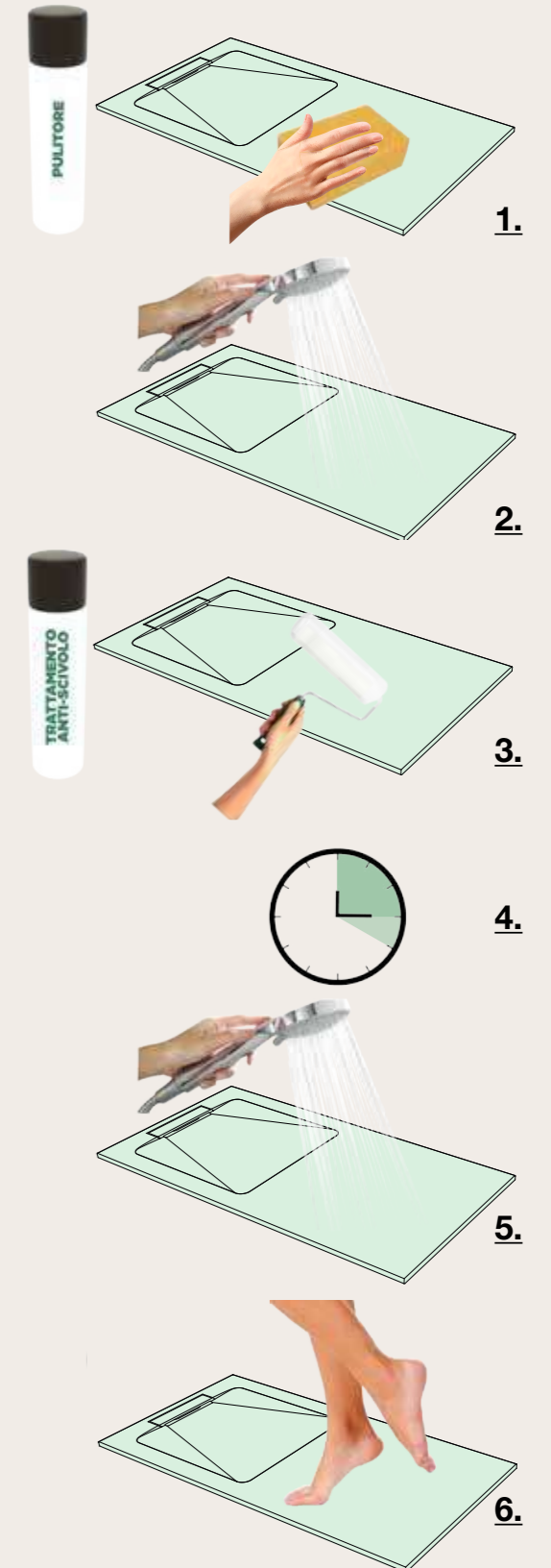

PERCHÉ SCEGLIERE UN PIATTO DOCCIA LONG LIFE H3 IN CERAMICA?

Why choose an LONG LIFE shower tray?

PERCHÉ È PIÙ ELEGANTE

- Stile elegante, design esclusivo e di prestigio
- Materia prima purissima
- Straordinaria planarità

BECAUSE IT'S MORE ELEGANT

- Elegant style, exclusive and prestigious design
- Pure raw material
- Extraordinary flatness

PERCHÉ È PIÙ FACILE DA PULIRE

- Resistente a graffi, macchie e agli agenti chimici
- Resiste allo sporco
- Durevole nel tempo

BECAUSE IT IS EASIER TO CLEAN

- Resistant to scratches or stains and to chemical agents
- Resistant to dirt
- Long Lasting

La PILETTA SIFONATA di ultima generazione ha una portata di scarico acqua di 60 lt al minuto. Massima ispezionabilità grazie alle due vaschette e allo speciale filtro ferma-capelli.

The latest generation SIPHONED WASTE has a range of water discharge of 60 liters per minute. Maximum inspection thanks to two trays and the special hair stop filter.



3 CM

L 70 - P100/140 CM

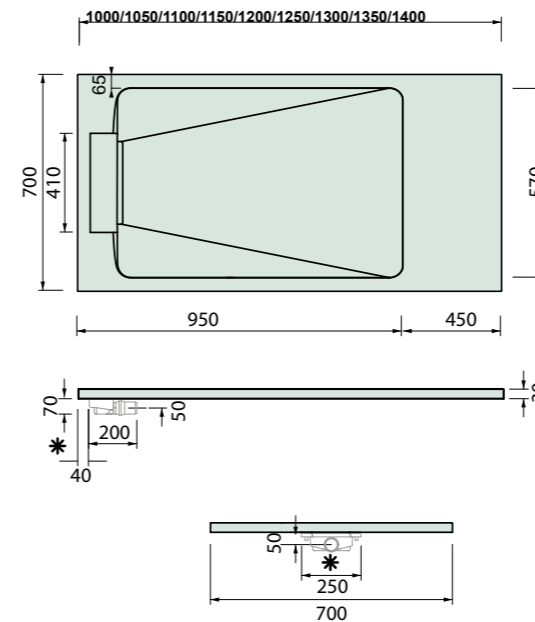

L 70 - P145/180 CM

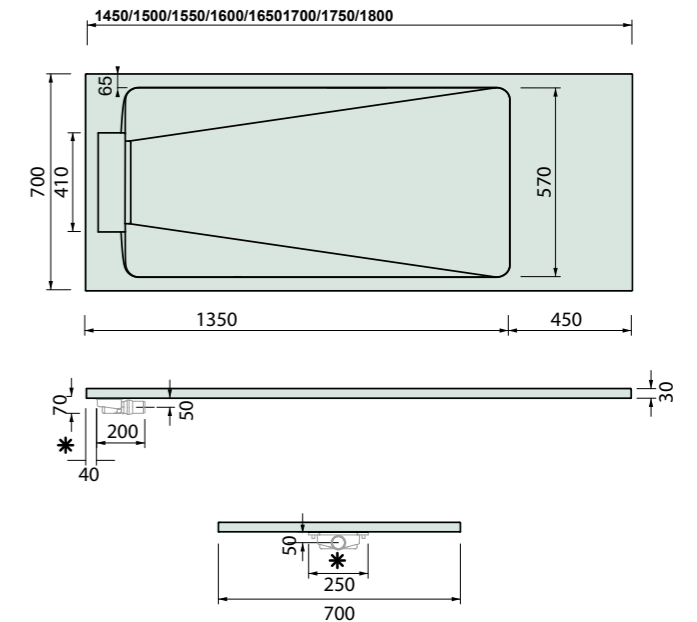

L 80 - P100/140 CM

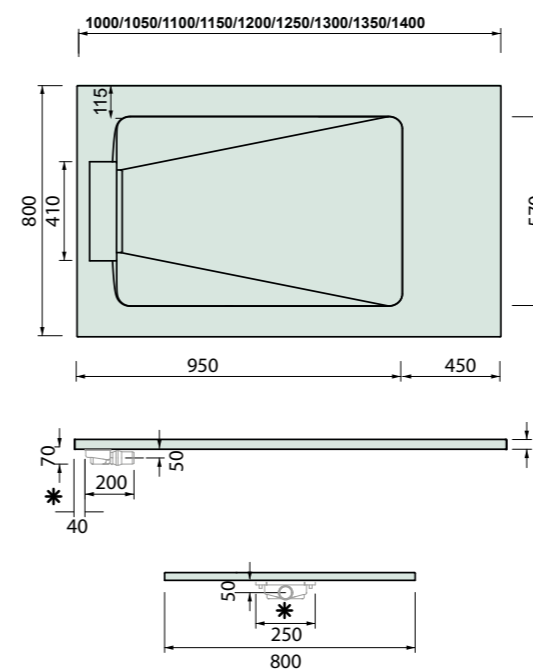

L 80 - P145/180 CM

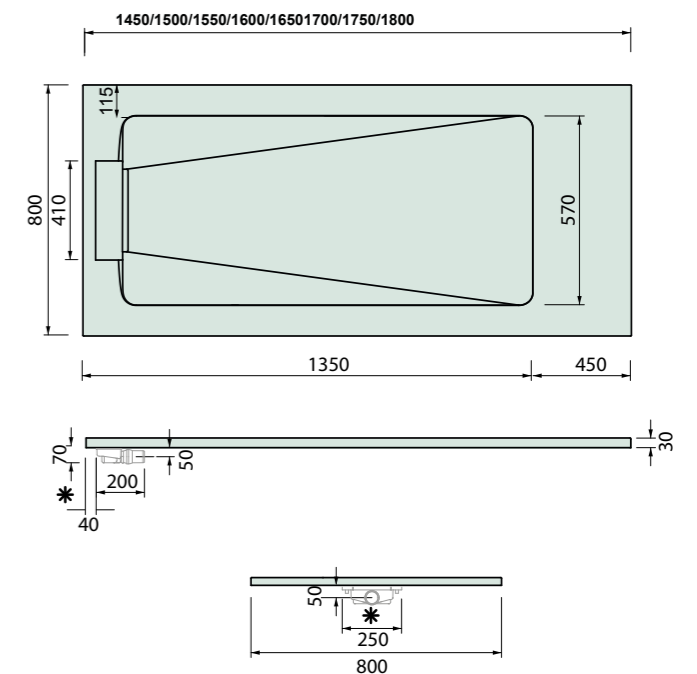

★ Misure reali piletta
Real drain measures

IL PIATTO DOCCIA PUÒ ESSERE
INSTALLATO SIA IN APPOGGIO
CHE A FILO PAVIMENTO

THE SHOWER TRAY CAN BE
INSTALLED, FLOOR LEVEL
OR LAID ON.



N.B.
Le misure indicate possono subire una variazione dello 0,8 % circa, dovuta ad usura degli stampi o a piccole variazioni delle caratteristiche tecniche relative alle materie prime che compongono l'impasto.

Indicated size could have a variation of about 0,8 % due to the usure of the moulds or the small variations of the raw materials' technical characteristics used in the mixture.

E

ENIGMA H 3 CM

È il piatto doccia rettangolare nell'esclusivo materiale Pietraluce e si presta a soddisfare qualsiasi richiesta di forma e misura. Pietraluce è brillante, impermeabile e con caratteristiche antibatteriche, anticalcaree, resiste agli acidi, ai solventi e a tutti i prodotti liquidi usati per la pulizia. La lavorazione del Pietraluce può essere forato o tagliato con normali utensili per legno. Elemento caratterizzante è la piletta grande ispezionabile che copre lo scarico dando una sensazione di perfetta uniformità.

It is the rectangular shower tray in the exclusive Pietraluce material and can satisfy any request for shape and size. Pietraluce is bright, waterproof and with unique characteristics: antibacterial, anti-limescale; resistant to: acids, solvents and all liquid products used for cleaning. Pietraluce can be drilled or cut with normal wood tools. Element characterizing is the large inspectable drain cover that covers the actual drain giving a feeling of perfect uniformity.



CERTIFICAZIONI

PIETRALUCE è un prodotto certificato secondo le più severe norme

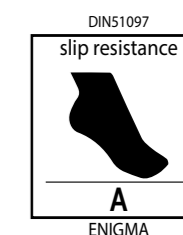

#PIETRALUCE

ENIGMA è il piatto doccia rettangolare nell'esclusivo materiale e disponibile in una vasta gamma di misure. Questo materiale è brillante, impermeabile e con caratteristiche antibatteriche, resiste a tutti i prodotti liquidi usati per la pulizia. Inoltre per la lavorazione il Pietraluce può essere forato o tagliato con normali utensili per legno. Elemento caratterizzante è la piletta grande ispezionabile che copre lo scarico dando una sensazione di perfetta uniformità.

ENIGMA is the rectangular shower tray in the exclusive material it is available in many different sizes. This material is shiny, waterproof and with antibacterial characteristics, it resists all liquid products used for cleaning. It can also be drilled or cut with normal wood tools. Characteristic element is the large inspectable drain that covers the drain giving a feeling of perfect uniformity.

Piatto doccia ENIGMA 70x180 Cotone /
ENIGMA shower tray 70x180 Cotone finish

Vasca Bull in Livin-Stone® Panna / Bull bathtub in Livin-Stone® Panna finish

#Cotone Revolution



Ogni mattina quando si posano i piedi su un piatto doccia ENIGMA, si ha come la sensazione di entrare nello spazio più intimo della propria casa e toccare una superficie confortevole e antiscivolo...
Il piatto doccia ENIGMA disegna lo spazio della zona doccia con il materiale innovativo Pietraluce che assicura resistenza, igiene e libertà di design. È materico, facile da pulire e, soprattutto, il colore rimane sempre inalterato nel tempo.

Every morning when you put your feet on an ENIGMA shower tray, you have the feeling of entering the most intimate space of your home and touching a comfortable and non-slip surface...

The shower tray ENIGMA draws the shower area with the innovative material Pietraluce that guarantees resistance, hygiene and design. It's easy to clean and the color remains unchanged over time.

#Verde Nuance



#ENIGMA

Piatto doccia ENIGMA 80x120 Verde Nuance /
ENIGMA shower tray 80x120 Verde Nuance finish



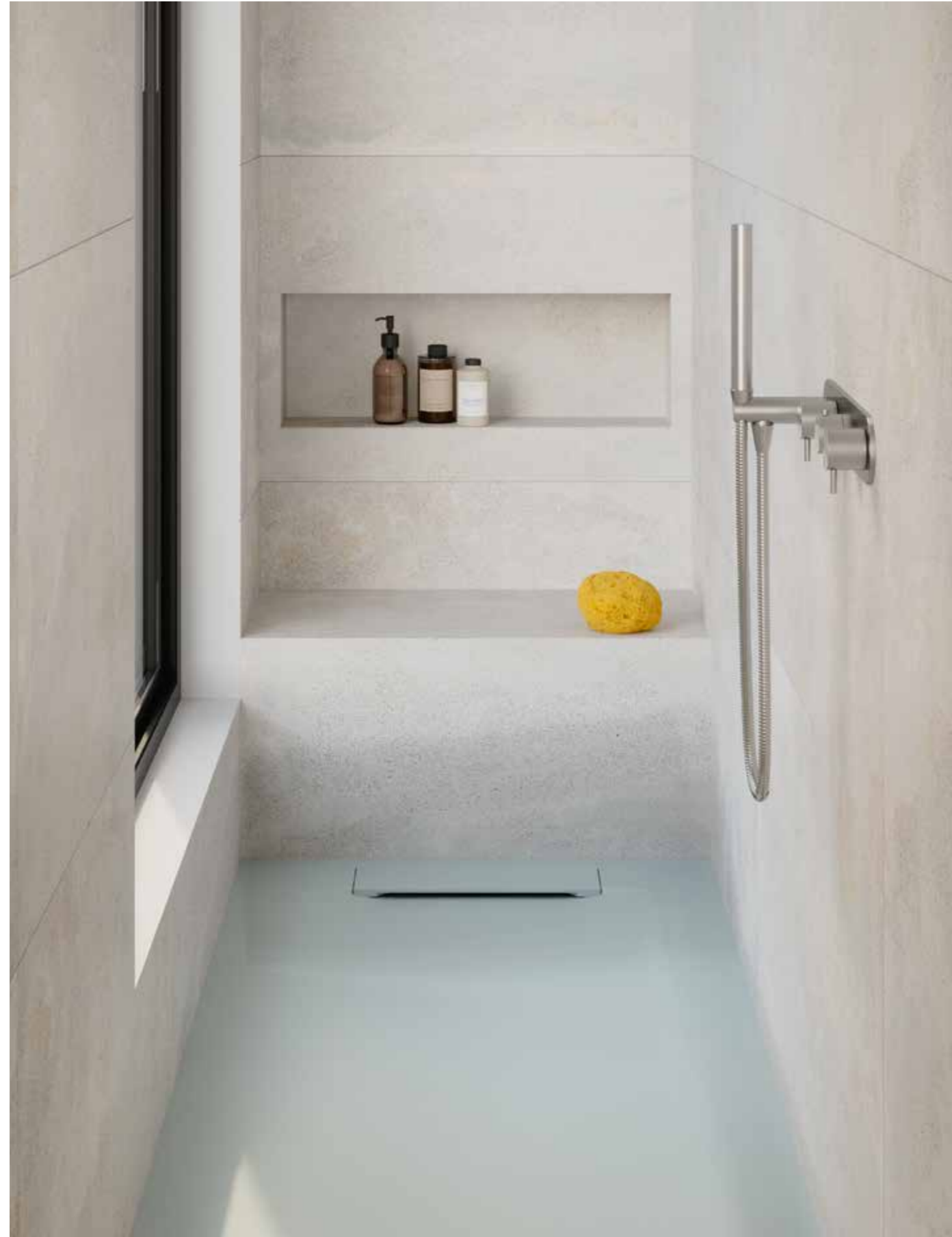

#ENIGMA

Piatto doccia ENIGMA 80x170 Celeste Nuance /
ENIGMA shower tray 80x170 Celeste Nuance finish



ENIGMA è un piatto doccia termoformato rettangolare per installazione sia in appoggio che a filo pavimento, nella finitura Celeste Nuance. Il copri-scarico nello stesso materiale è ispezionabile il tutto corredato da sifone e piletta.

#Celeste Nuance



ENIGMA is a rectangular thermoformed shower tray can be installed laid on or floor level, in Celeste Nuance finish. The drain cover in the same material can be inspected, all equipped with siphon and drain.



**SOLO IN CASO
DI PICCOLI DANNI**
ONLY IN CASE OF
MINOR DAMAGE

#Rosa Nuance

Il tuo piatto doccia Enigma si è danneggiato o scheggiato in maniera accidentale?

Your ENIGMA shower tray has been accidentally damaged or scratched?

Se il tuo piatto doccia si è graffiato, crepato o scheggiato leggermente, con questo kit di riparazione potrai recuperarlo e rigenerarlo.

if your shower tray is scratched or slightly damaged with this repair kit you can recover and regenerate it.

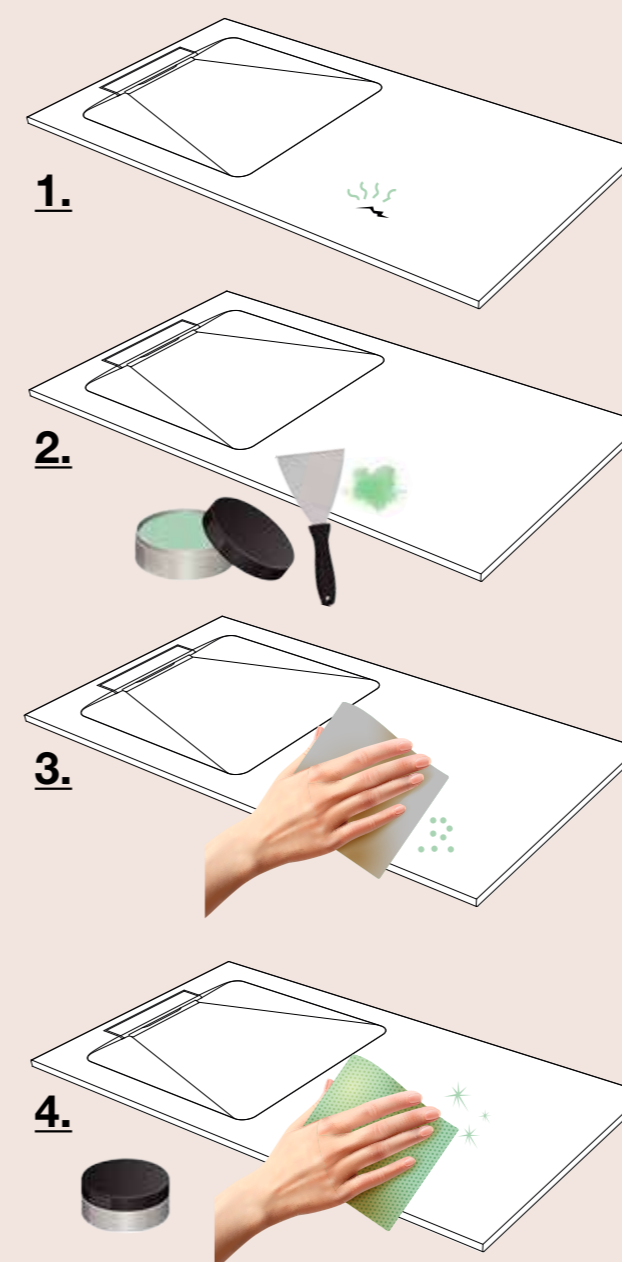

Grazie ai nostri **kit di riparazione**, avrai la possibilità di mantenere al meglio il tuo piatto doccia **ENIGMA** in Pietraluce. I kit in vendita sono progettati per essere semplici da utilizzare e per essere duraturi nel tempo. Grazie a questi kit potrai rimuovere graffi o piccole scheggiature senza la necessità di dover smontare il piatto doccia.

Thanks to our **repair kits**, you will be able to maintain your **ENIGMA** shower tray in the best possible way. The kits for sale are designed to be simple to use and to be long lasting. Thanks to these kits you can remove scratches or small chips without remove the shower tray.



Kit ripristino per
piatti doccia **ENIGMA**
ENIGMA shower trays kit
Cod. KRE

ASSISTENZA CLIENTI

Per qualunque informazione non esitare a contattarci. Il nostro team qualificato ed esperto, potrà aiutarti e rispondere a tutte le tue domande di natura tecnica. E non solo! Puoi usufruire anche della consulenza gratuita di un nostro esperto per trovare la soluzione migliore per il tuo contesto e le tue esigenze.

COSTUMER CARE

For any information of a technical nature, or installation question our team will be happy to help you.

Telefono: **0761 541055**

Email: **info@sdrcceramiche.it**

PERCHÉ SCEGLIERE UN PIATTO DOCCIA ENIGMA?

Why choose an Enigma shower tray?

PERCHÉ SI PUÒ TAGLIARE

- Stile elegante, design esclusivo e di prestigio
- Materia prima purissima
- Superficie dal tocco morbido
- Straordinaria planarità

BECAUSE IT CAN BE CUT

- Elegant style, exclusive and prestigious design
- Pure raw material
- Soft surface
- Extraordinary flatness

PERCHÉ È PIÙ RESISTENTE

- 3 volte più resistente al carico di rottura
- Resiste allo sporco
- Facile da pulire
- Antibatterico

BECAUSE IT'S MORE RESISTANT

- 3 times more resistant to breaking load
- Resists dirt
- Easy to clean
- Antibacterial

PERCHÉ È ECOSOSTENIBILE

- Materiale più durevole nel tempo
- Fonti energetiche rinnovabili
- Minori consumi di energia e minori emissioni di CO²

BECAUSE IT'S ECO-FRIENDLY

- Longer lasting material
- Renewable energy sources
- Lower energy consumption and lower CO² emissions
- Recycled material

La PILETTA SIFONATA di ultima generazione ha una portata di scarico acqua di 60 lt al minuto. Massima ispezionabilità grazie alle due vaschette e allo speciale filtro ferma-capelli.

The latest generation SIPHONED WASTE has a range of water discharge of 60 liters per minute. Maximum inspection thanks to two trays and the special hair stop filter.



3 CM



ENIGMA SI PUÒ TAGLIARE E FORARE CON NORMALI UTENSILI PER LEGNO ED HA UNA LAVORABILITÀ PARAGONABILE A QUELLA DI UN LEGNO DURO

ENIGMA CAN BE CUT AND DRILLED WITH NORMAL TOOLS FOR WOOD AND HAS A WORKABILITY SIMILAR TO HARD WOOD

L 70 CM

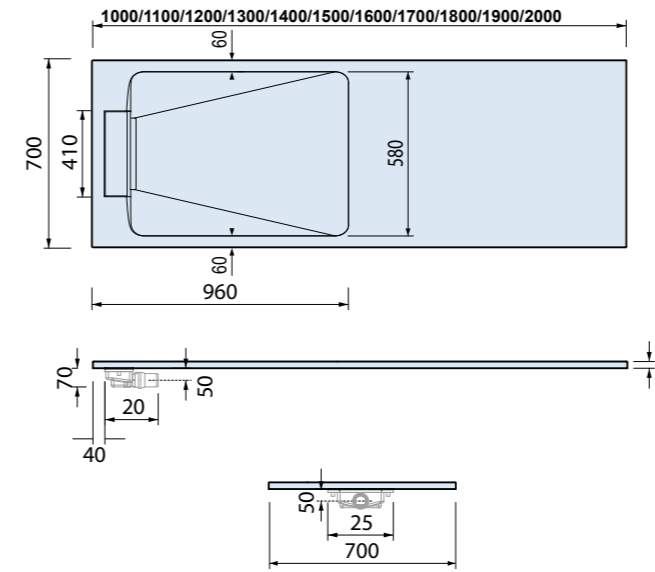

L 80 CM

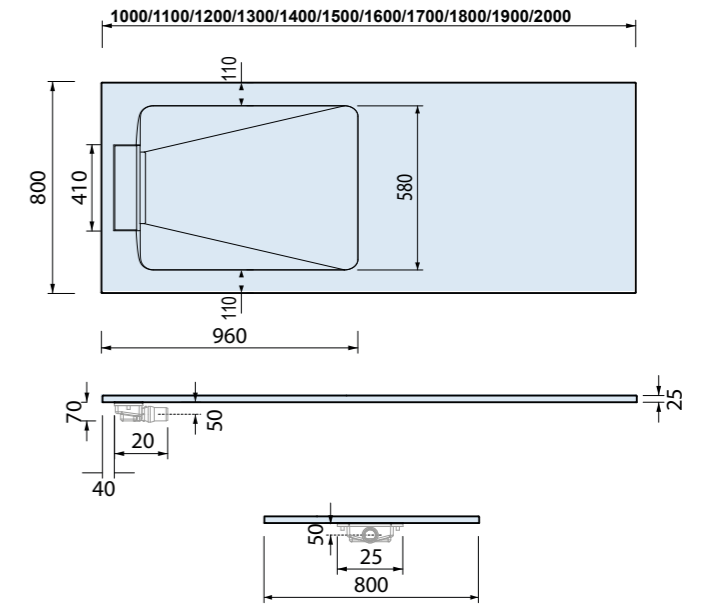

L 90 CM

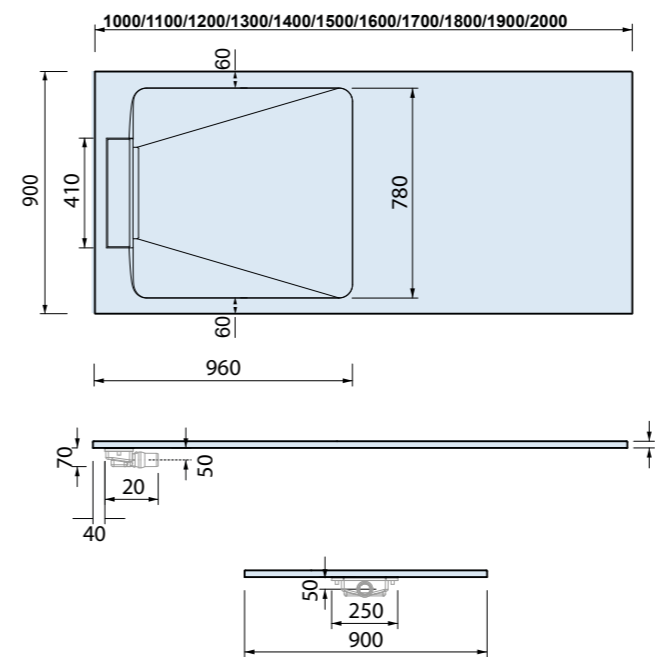

L 100 CM

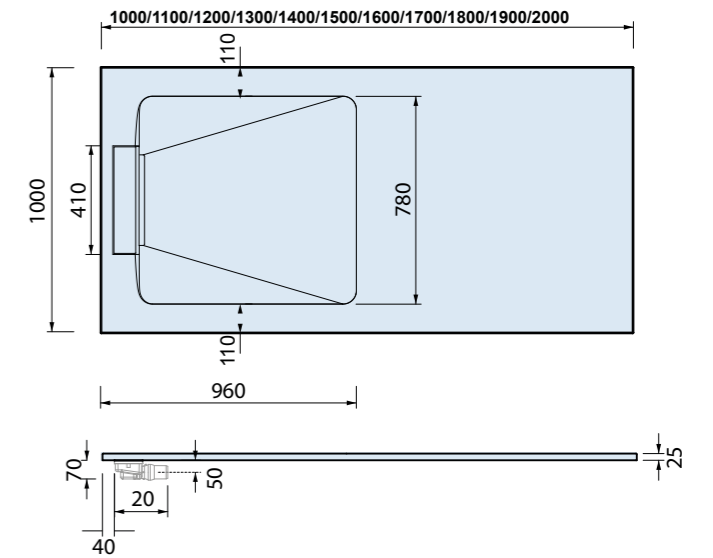

IL PIATTO DOCCIA PUÒ ESSERE INSTALLATO SIA IN APPOGGIO CHE A FILO PAVIMENTO

THE SHOWER TRAY CAN BE INSTALLED, FLOOR LEVEL OR LAID ON.

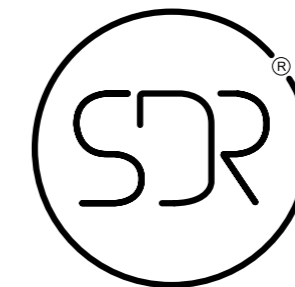

N.B.
Le misure indicate possono subire una variazione dello 0,8 % circa, dovuta ad usura degli stampi o a piccole variazioni delle caratteristiche tecniche relative alle materie prime che compongono l'impasto.

Indicated size could have a variation of about 0,8 % due to the usure of the moulds or the small variations of the raw materials' technical characteristics used in the mixture.



Il packaging fa la differenza.

Packaging makes the difference

Uno dei passaggi più delicati nella fase di produzione e consegna di un piatto doccia è il trasporto.

One of the most delicate steps in the production phase and delivery of a shower tray is transport.

Ci serviamo di ottimi trasportatori, selezionati in quanto esperti nella consegna di elementi di arredo. Nonostante ciò l'elemento primario per mantenere integro il piatto doccia è un buon e resistente imballo. **Negli anni abbiamo sviluppato un particolare imballo che è in grado di proteggere molto bene il piatto durante tutte le fasi di consegna.** Per evitare movimenti ed irrigidire il tutto, vengono posizionati alcuni distanziali di polistirolo per riempire i rimanenti spazi vuoti.

We use excellent carriers, selected as experts in the delivery of fragile items. Despite this, the primary element to keep the shower tray intact is a good and resistant packaging. **Over the years we have developed a particular packaging that is able to protect the tray very well during all stages of delivery.** To avoid movements and to make the box more resistant, some polystyrene spacers are placed to fill the empty spaces.

DISTANZIALI DI
POLISTIRENE SU
TUTTI I LATI

POLYSTYRENE
SPACERS ON ALL
THE SIDES

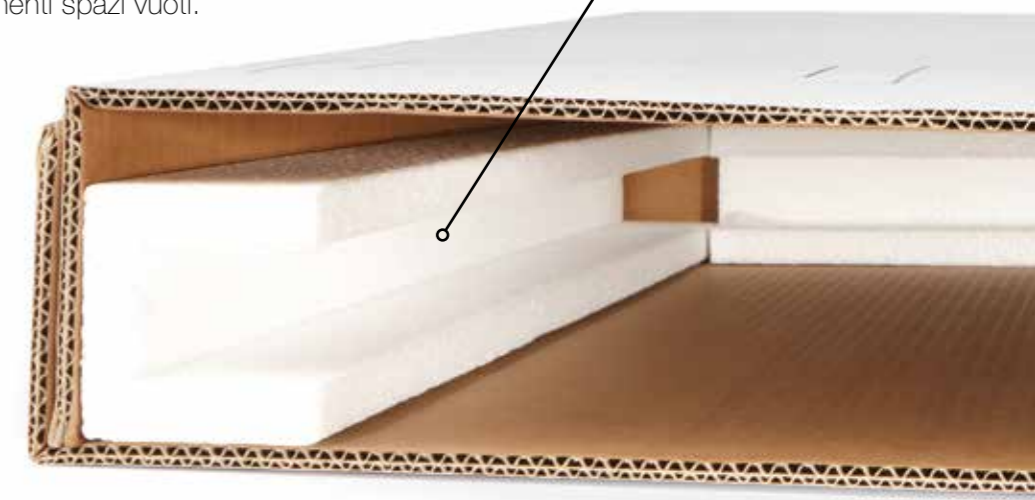

Istruzioni & Garanzia.



IMPORTANTE

Reclami o difetti, dopo la posa in opera, non saranno motivo di contestazione qualora il difetto dovesse essere visibile e/o verificabile prima dell'installazione, (come da adesivo riportato su ogni singola confezione).

Quindi è consigliabile verificare, prima della definitiva installazione, pendenze, e o imperfezioni che ne potrebbero impedire il corretto funzionamento.

L'installazione implica l'accettazione dell'articolo stesso, la garanzia non copre difetti che derivano da un utilizzo non conforme alla tipologia del prodotto; manomissioni, alterazioni, normale deperimento d'uso, manutenzione non idonea ecc. escludendo qualsiasi responsabilità per l'uso di prodotti aggressivi, abrasivi, ecc. che possano deteriorare le superfici.

La garanzia è in ogni caso, esclusivamente limitata alla sostituzione della merce con **l'esclusione di ogni altra prestazione e onere accessorio. L'azienda non risponderà in nessun caso di costi e oneri relativi a montaggio, smontaggio, posa in opera, ecc.**

La durata della garanzia del prodotto è fissata ad anni due dalla data di acquisto del prodotto.

CONSIGLI D'INSTALLAZIONE E DI USO E MANUTENZIONE



LONG LIFE



ENIGMA

File disponibili anche nell'area tecnica sul sito
www.sdrceramiche.it
e in formato cartaceo all'interno di ogni confezione

Instructions & Warranty.



ATTENTION

Complaints or defects, after installation, will not be accepted if visible before installation, (as per sticker shown on each individual package).

Therefore it is recommended to check, before the final installation, slopes, and or imperfections that could prevent correct operation.

The installation implies the acceptance of the article itself, the guarantee it does not cover defects deriving from use that does not conform to the typology of the product; tampering, alterations, normal deterioration of use, unsuitable maintenance etc. excluding any responsibility for the use of aggressive, abrasive products, etc. that may deteriorate the surfaces.

In any case, warranty is exclusively limited to replacement of the goods with **the exclusion of any other service or accessory charge. The company will not be liable under any circumstances for costs and charges relating to assembly, disassembly, installation, etc.**

The duration of warranty is two years from the date of purchase of the product.

ADVICE FOR INSTALLATION, USE AND MAINTENANCE



LONG LIFE



ENIGMA

Files are also available in the technical area on the website
www.sdrceramiche.it
and in paper format inside each package

MM

MOBILI E TOP

Da un approccio sofisticato al mondo bagno, nasce SOLIDO, il nuovo mobile bagno in Solid Surface in grado di soddisfare le richieste della clientela più esigente.

Completano la sezione Mobili il modulo con cassettera (30-60-90-120 cm) che si posiziona sotto la consolle REVOLUTION® dando vita a molteplici composizioni. I top in MDF nella finitura Neve consentono di arredare la stanza da bagno in modo elegante e funzionale. La vasta gamma delle misure (tutte con profondità 50 cm) ma con lunghezza da 100 a 240 cm permette la collocazione e la personalizzazione al centimetro.

FURNITURE AND TOPS. From a sophisticated approach to the bathroom world, born SOLIDO, the new Solid Surface bathroom furniture able to satisfy the requests of the most demanding customers. The furniture section is completed by the module with drawers (30-60-90-120 cm) which is positioned under the REVOLUTION® console, giving life to multiple compositions. The MDF tops in the Neve finish allow you to furnish the bathroom in an elegant and functional way. The wide range of sizes (all with a depth of 50 cm) but with a length from 100 to 240 cm allows placement and customization to the centimeter.



#Panna Essence

#MOBILE SOLIDO 140 cm

Mobile Solido cm 160x46 Panna + top doppia vasca integrata /
Solido Cabinet 160x46 cm Panna finish + top with built-in double washbasin
Specchio touch-screen retro illuminato Led /
Backlit Led mirror with touch ON/OFF sensor switch

Forme pulite, rigorose e minimali ma non per questo asettiche, superfici che rivelano l'essenza più vera dei materiali, gli accostamenti ricercati come il materiale Solid Surface sia per il mobile che per il lavabo Qube 12 in tonalità Avio creano un'uniformità di nuance e superfici omogenee.

Rigorous and minimal shapes but not aseptic, surfaces that reveal the truest essence of the materials, refined combinations such as the Solid Surface material for both the cabinet and the Qube 12 washbasin in Avio create uniformity of colors and homogeneous surfaces.



#Avio Revolution



#MOBILE SOLIDO 120 cm

Mobile Solido cm 120x46 Avio + Lavabo Qube 12 in Livin-Stone® Avio /
Solido Cabinet 120x46 Avio finish + Qube 12 washbasin Livin-Stone® Avio finish
Specchio touch-screen retro illuminato Led / Backlit Led mirror with touch ON/OFF sensor switch



#Sabbia Essence

#MOBILE SOLIDO 120 cm

Mobile Solido cm 120x46 Sabbia + Lavabo Qube 11 Sabbia finish /
 Solido Cabinet 120x46 Sabbia finish + Qube 11 washbasin Sabbia finish
 Specchio touch-screen retro illuminato Led / Backlit Led mirror with touch ON/OFF sensor switch



#Grigio Nuance

#MOBILE SOLIDO 120 cm

Mobile Solido cm 120x46 Grigio Nuance + Lavabo Qube 11 Grigio Nuance finish /
 Solido Cabinet 120x46 Grigio Nuance finish + Qube 11 washbasin Grigio Nuance finish
 Specchio touch-screen retro illuminato Led / Backlit Led mirror with touch ON/OFF sensor switch



Una combinazione di forme e linee che disegnano lo spazio bagno. Il cassetto per la consolle REVOLUTION® è una proposta che esprime soluzioni compositive concrete, valorizzate da equilibri dimensionali misurati e cromie delicate. Contiene e nasconde gli oggetti quotidiani con discrezione e grande capienza. Geometrie tanto semplici quanto flessibili per comporre ambienti moderni e funzionali.

A combination of shapes and lines draws the bathroom space. REVOLUTION® drawer for the console is a concrete proposal, enhanced by measured dimensional balances and delicate colors. Contains and hides everyday objects with discretion and large capacity. Simple and flexible geometries to compose modern and functional environments.



#CASSETTO REVOLUTION 120 cm

Consolle Revolution 95 Bianco Lucido / Revolution 95 console Bianco Lucido finish
 Cassetto Revolution 120 Aloe / Revolution 120 drawer Aloe finish
 Specchio touch-screen retro illuminato Led / Backlit Led mirror with touch ON/OFF sensor switch



#REVOLUTION 95

Console Revolution 95 Panna / Revolution 95 console Panna finish
Cassetto Revolution 120 Panna / Revolution 120 drawer Panna finish
Specchio touch-screen retro illuminato Led / Backlit Led mirror with touch ON/OFF sensor switch



#Panna Essence



**#CASSETTO
REVOLUTION**

Tante sono le combinazioni, il cassetto con kit di fissaggio a parete può essere montato in diverse posizioni.

Infinity of combination. Wall mounted drawer can be installed in different position.

**#Panna Essence****#Aloe Revolution****#Grafite Essence****#Sabbia Essence****#Beige Nuance****#Verde Nuance****#Rosa Nuance****#Celeste Nuance**

#Il cassetto REVOLUTION® è disponibile in tutti i colori presenti a catalogo: Cotone, Aloe, Camelia Avio, Grafite, Sabbia, Magnesio, Caffè, Ghiaccio, nei colori Nuance e in quattro misure.

#REVOLUTION® drawer is available in all the colors in the catalogue: Cotone, Aloe, Camelia Avio, Grafite, Sabbia, Magnesio, Caffè, Ghiaccio, in the Nuance colors and in four sizes.

K

KING **RUBINETTI E ACCESSORI**

SDR firma rubinetti di design e complementi di alta qualità in acciaio inox spazzolato. Una collezione che dura nel tempo e sorpassa le mode. Prodotti innovativi che nascono dall'unione tra un'avanzata ricerca tecnica e tutta la sapienza di una decennale tradizione artigiana. Un design elegante e ricercato, reso unico dal carattere dell'acciaio inox, materiale dalle molteplici qualità: ecologico, igienico, estremamente resistente alla corrosione. A richiesta leva comando color Panna.

FAUCETS AND ACCESSORIES. SDR signs design faucets and high quality brushed stainless steel accessories. A collection that lasts over time and surpasses fashion. Innovative products that come from the union between an advanced technical research and all the wisdom of a ten-year artisan tradition.

An elegant and refined design, made unique by the character of stainless steel, a material with multiple qualities: ecological, hygienic, extremely resistant to corrosion. On request Panna-colored handle.



L'intera collezione di rubinetti e accessori KING è possibile visionarla nell'Area Tecnica / Listino a pag. 192

The entire collection of KING faucets and accessories can be viewed in the Technical Area / Price List pag. 192



Miscelatore monocomando lavabo senza saltarello e scarico /
Single lever basin mixer without pop-up waste and drain



Miscelatore monocomando lavabo rialzato senza saltarello e scarico /
Single lever high basin mixer without pop-up waste and drain

Piantana lavabo senza saltarello e scarico /
Floor-standing basin mixer without pop-up waste and drain



Miscelatore lavabo due fori con canna curva L=190 e piastra unica senza saltarello e scarico /
2-hole built-in mixer with L=190 curved spout and entire backplate without pop up waste and drain



Miscelatore lavabo due fori con canna curva L=190 e piastra unica senza salterello e scarico /
2-hole built-in mixer with L=190 curved spout and entire backplate without pop up waste and drain



Miscelatore monocomando bidet senza saltarello e scarico /
Single level bidet mixer without pop-up waste and drain



Miscelatore doccia incasso con deviatore 2 vie integrato /
Built-in shower mixer with integrated 2-ways diverter



Piantana vasca con doccetta / Free-standing bath set with shower hand



#AREA TECNICA



Serie di sanitari _ Sanitary wares

BULL.....	p. 246-247
QUADRA.....	p. 248-249
NEOS.....	p. 250-251
FOX.....	p. 252-253
BULL500.....	p. 254-255
REVOLUTION.....	p. 256-257

Lavabi d'arredo _ Washbasins

CERAMICA.....	p. 258-264
REVOLUTION.....	p. 264
LIVIN-STONE®.....	p. 266-268

Vasche free-standing _ Free-standing Bathtubs

BULL.....	p. 269
QUADRA.....	p. 269
OVALE REVOLUTION.....	p. 270
QUADRA REVOLUTION.....	p. 270

Piatti doccia _ Shower trays

LONG LIFE (Ceramica).....	p. 272-273
ENIGMA (Pietraluce).....	p. 274

Rubinetti e accessori _ Taps and accessories

KING (acciaio inox spazzolato brushed stainless steel).....	p. 276-295
Ricambi KING.....	p. 296

Specchi _ Mirrors

Specchi retroilluminati - Backlit mirrors...	p. 297
--	--------

Mobili & Top _ Furniture & Tops

SOLIDO.....	p. 298-305
REVOLUTION.....	p. 306-307

Ricambi.....	p. 308-309
--------------	------------

INFORMAZIONI RELATIVE ALL'AREA TECNICA: TECHNICAL AREA INFORMATIONS:

Legenda dei simboli alla predisposizione
della rubinetteria dei lavabi.

Note referred to the symbols showing
the taps position on washbasins.

Sul sito
www.sdr ceramiche.it
potete scaricare le schede tecniche sempre
aggiornate in formato A4 e istruzioni di montaggio

Please download on
www.sdr ceramiche.it
latest technical sheets in A4 format
and fixing instruction

Tutti i prodotti rispettano la normativa europea
UNI-EN997. In alcuni casi è necessario usare un
riduttore di flusso (presente nella scatola) qualora la
pressione dei sistemi di scarico sia troppo elevata.

All the products are made in accordance with
UNI-EN997 European standards. In case of high
pressure flushing systems, you may use the flow
reductor included in the box.

#BULL

246



Cod. WCBLR NO-RIM

Cod. WCBLV VERIBO

Vaso con scarico a parete trasformabile a pavimento tramite curva tecnica.

BTW wc with wall trap changeable into floor trap by technical bend.

- Kg 28
- cm 53x36,5xh 42
- Pz./Pallet 15

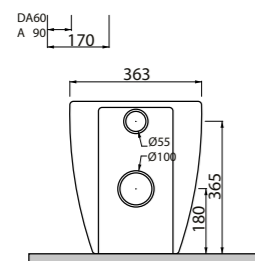
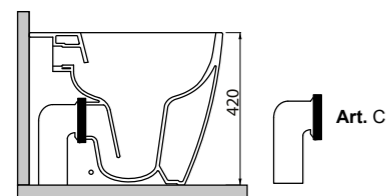
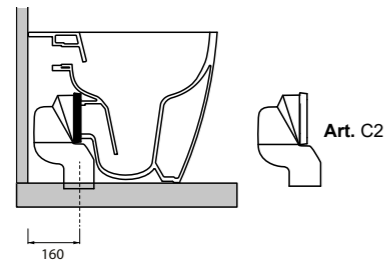
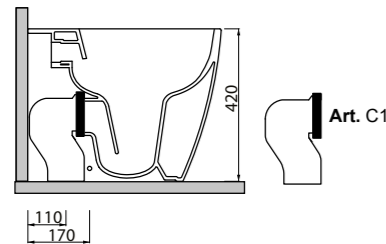
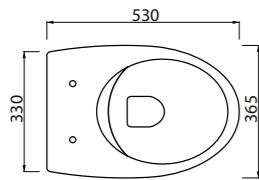

INSTALLAZIONE TRASLATA FLOOR DRAIN ADJUSTABLE FLUSH

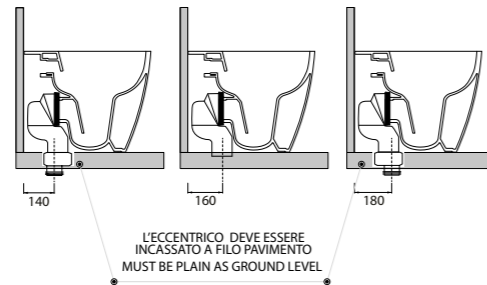

L'ECCENTRICO DEVE ESSERE
INCASSATO A FILO PAVIMENTO
MUST BE PLAIN AS GROUND LEVEL

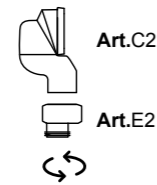

Cod. C1

Raccordo per scarico pavimento.
Elbow pipe for floor drain.

- Kg 0,5

Cod. C2

Curva tecnica per scarico traslato.
Special elbow pipe for
translated outlet.

- Kg 0,5

Cod. C3

Curva tecnica per scarico arretrato.
Special elbow pipe for
backward outlet.

- Kg 0,5

Cod. E2

Raccordo eccentrico.
Eccentric fitting.

- Kg 0,5



Cod. BDBLL

Bidet monoforo a terra.
BTW single hole bidet.

- Kg 24
- cm 53x36,5xh 42
- Pz./Pallet 15

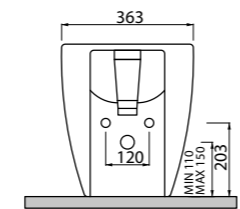
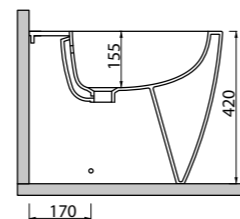
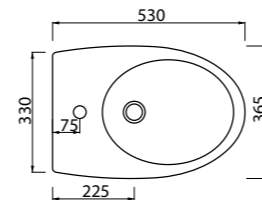

INSTALLAZIONE INSTALLATION

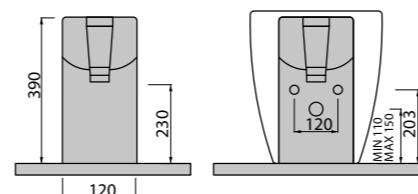

Cod. WCSBLR NO-RIM

Cod. WCSBLV VERIBO

Vaso sospeso con fissaggio
a scomparsa.

Wall-hung wc with hidden fixing.

- Kg 24
- cm 53x36xh 37
- Pz./Pallet 15

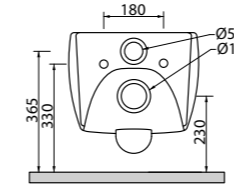
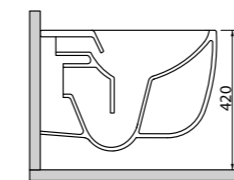
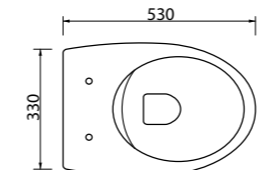

Cod. BDSBLL

Bidet sospeso monoforo
con fissaggio a scomparsa.

Single hole wall-hung bidet
with hidden fixing.

- Kg 20
- cm 53x36,5xh 29
- Pz./Pallet 15

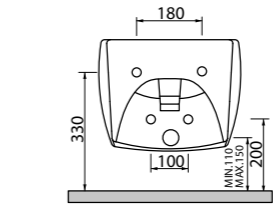
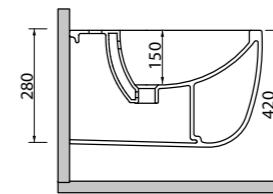
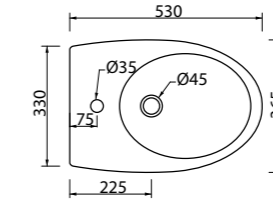

INSTALLAZIONE INSTALLATION

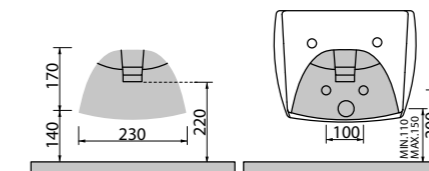

247



Cod. CWBLR

Coprivaso in termindurente
con cerniera a sgancio rapido.

Quick-release thermoset seat cover.

- Kg 2,5
- Pz./Pallet 150



Cod. CWBLRF

Coprivaso soft close in termindurente
con cerniera a sgancio rapido.

Soft close quick-release thermoset seat cover.

- Kg 2,5
- Pz./Pallet 150



Cod. L1

Sistema universale a L per
sanitari sospesi.
Universal L-shaped fixing
system wall-hung wc/bidet.

- Kg 1,5



Cod. T1

Raccordo per scarico a parete.
Pipe for wall drain.

- Kg 0,2



Cod. P1

Protezione e guarnizione
antirumore.
Acoustic and crash protection
pad for sanitaryware.

- Kg 0,1

#QUADRA

248



Cod. **WCQDR** NO-RIM

Cod. **WCQDV** VENTIGI

Vaso con scarico a parete trasformabile a pavimento tramite curva tecnica.

BTW wc with wall trap changeable into floor trap by technical bend.

- Kg 28
- cm 56x36xh 43
- Pz./Pallet 15

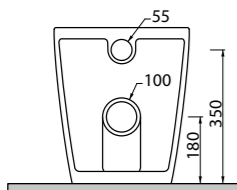
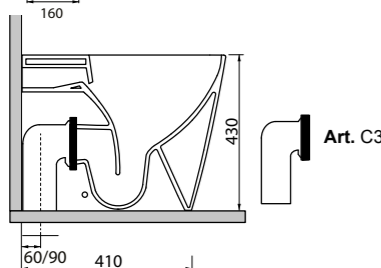
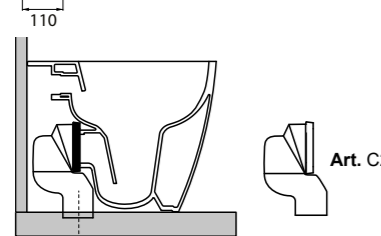
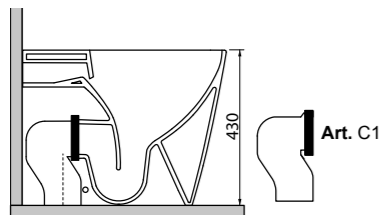
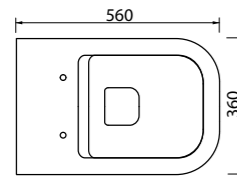

INSTALLAZIONE TRASLATA FLOOR DRAIN ADJUSTABLE FLUSH

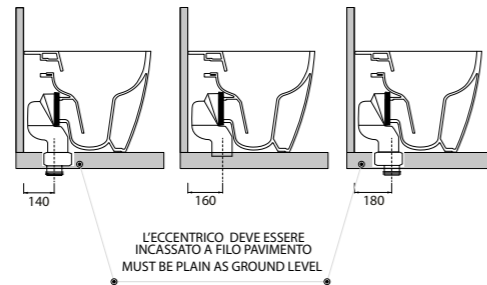

L'ECCENTRICO DEVE ESSERE
INCASSATO A FILO PAVIMENTO
MUST BE PLAIN AS GROUND LEVEL

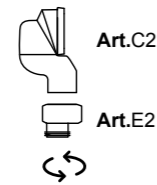

Cod. **C1**

Raccordo per scarico pavimento.
Elbow pipe for floor drain.

- Kg 0,5

Cod. **C2**

Curva tecnica per scarico traslato.
Special elbow pipe for
traslated outlet.

- Kg 0,5

Cod. **C3**

Curva tecnica per scarico arretrato.
Special elbow pipe for
backward outlet.

- Kg 0,5

Cod. **E2**

Raccordo eccentrico.
Eccentric fitting.

- Kg 0,5



Cod. **BDQD**

Bidet monoforo a terra.
BTW single hole bidet.

- Kg 26
- cm 56x36xh 43
- Pz./Pallet 15

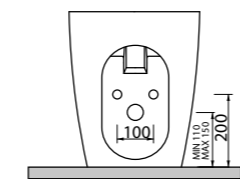
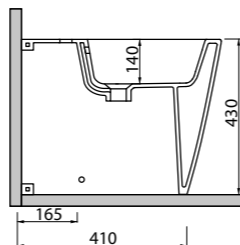
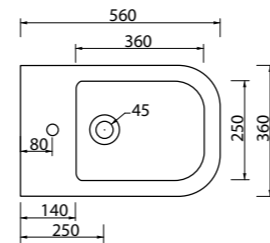

INSTALLAZIONE INSTALLATION

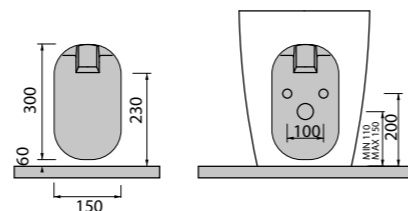

Cod. **WCSQDR** NO-RIM

Cod. **WCSQDV** VENTIGI

Vaso sospeso con fissaggio
a scomparsa.

Wall-hung wc with hidden fixing.

- Kg 27
- cm 55x36xh 37
- Pz./Pallet 15

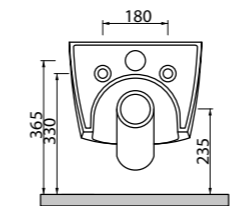
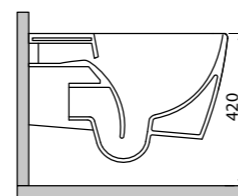
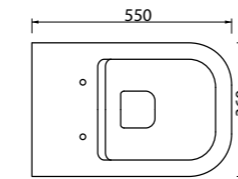

Cod. **BDSQD**

Bidet sospeso monoforo
con fissaggio a scomparsa.

Single hole wall-hung bidet
with hidden fixing.

- Kg 24
- cm 55x36xh 29
- Pz./Pallet 15

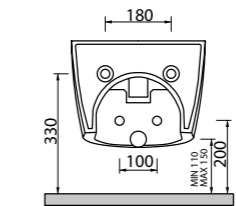
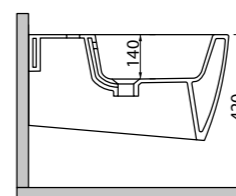
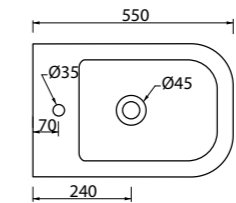

INSTALLAZIONE INSTALLATION

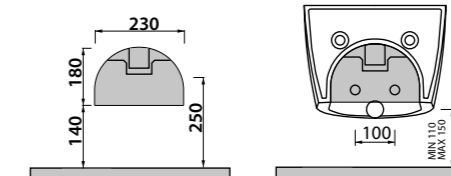

Cod. **CWQDR**

Coprivaso in termindurente
con cerniera a sgancio rapido.

Quick-release thermoset seat cover.

- Kg 2,5
- Pz./Pallet 150



Cod. **CWQDRF**

Coprivaso soft close in termindurente
con cerniera a sgancio rapido.

Soft close quick-release thermoset seat cover.

- Kg 2,5
- Pz./Pallet 150

Cod. **L1**

Sistema universale a L per
sanitari sospesi.
Universal L-shaped fixing
system wall-hung wc/bidet.

- Kg 1,5

Cod. **T1**

Raccordo per scarico a parete.
Pipe for wall drain.

- Kg 0,2

Cod. **P1**

Protezione e guarnizione
antirumore.
Acoustic and crash protection
pad for sanitaryware.

- Kg 0,1

249

N.B.: Le misure indicate possono subire una variazione dello 0,8 % circa, dovuta ad usura degli stampi o a piccole variazioni delle caratteristiche tecniche relative alle materie prime che compongono l'impasto.
N.B.: The measures indicated may undergo a variation of about 0,8%, due to wear of the molds or to small variations in the technical characteristics of the raw materials that make up the mixture.

#NEOS

250



Cod. WCN

Vaso VERTIGO con scarico a parete trasformabile a pavimento tramite curva tecnica.

BTW VERTIGO wc with wall trap changeable into floor trap by technical bend.

- Kg 28
- cm 55x36xh 42
- Pz./Pallet 15

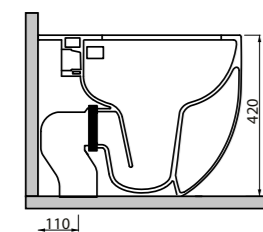
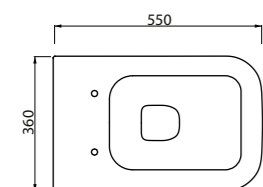

Art. C1

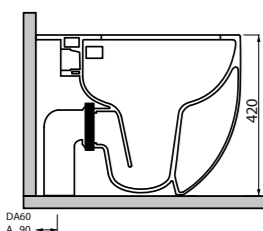

Art. C3

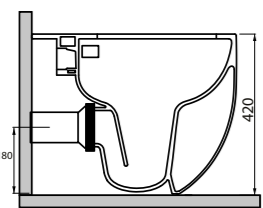

Art. T1

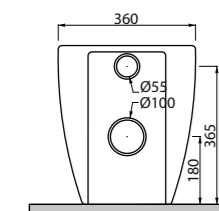

INSTALLAZIONE TRASLATA FLOOR DRAIN ADJUSTABLE FLUSH

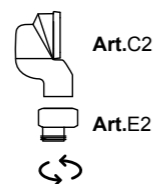
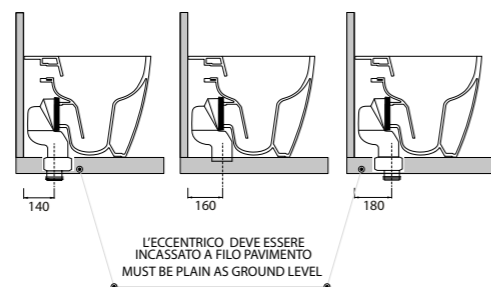

Cod. C1

Raccordo per scarico pavimento. Elbow pipe for floor drain.

- Kg 0,5

Cod. C2

Curva tecnica per scarico traslato. Special elbow pipe for traslated outlet.

- Kg 0,5

Cod C3

Curva tecnica per scarico arretrato. Special elbow pipe for backward outlet.

- Kg 0,5

Cod. E2

Raccordo eccentrico. Eccentric fitting.

- Kg 0,5



Cod. BDN

Bidet monoforo a terra. BTW single hole bidet.

- Kg 26
- cm 55x36xh 42
- Pz./Pallet 15

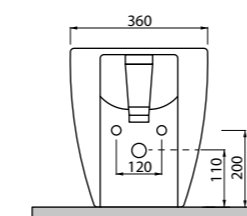
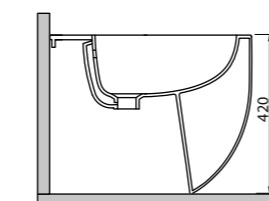
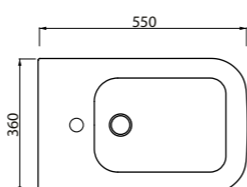

Cod. WCSN

Vaso sospeso VERTIGO con fissaggio a scomparsa.

Wall-hung NO-RIM wc with hidden fixing.

- Kg 27
- cm 55x36xh 37
- Pz./Pallet 15

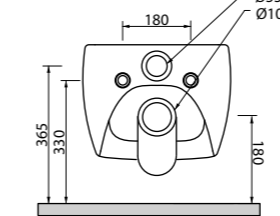
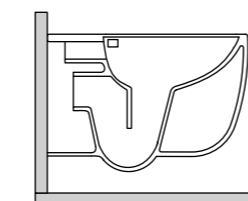
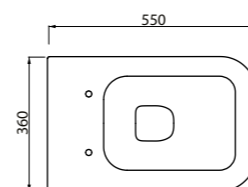

Cod. BDSN

Bidet sospeso monoforo con fissaggio a scomparsa.

Single hole wall-hung bidet with hidden fixing.

- Kg 24
- cm 55x36xh 29
- Pz./Pallet 15

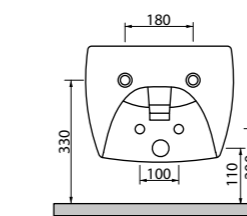
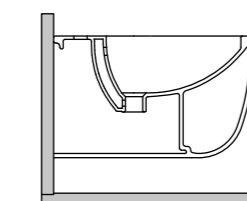
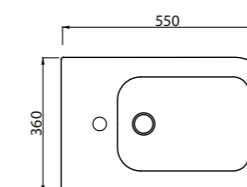

251



Cod. CWN

Coprivaso in termindurente con cerniera a sgancio rapido.

Quick-release thermoset seat cover.

- Kg 2,5
- Pz./Pallet 150



Cod. CWNF

Coprivaso soft close in termindurente con cerniera a sgancio rapido.

Soft close quick-release thermoset seat cover.

- Kg 2,5
- Pz./Pallet 150

Cod. L1

Sistema universale a L per sanitari sospesi. Universal L-shaped fixing system wall-hung wc/bidet.

- Kg 1,5

Cod T1

Raccordo per scarico a parete. Pipe for wall drain.

- Kg 0,2

Cod. P1

Protezione e guarnizione antirumore. Acoustic and crash protection pad for sanitaryware.

- Kg 0,1



Cod. WCF

Vaso NO-RIM con scarico a parete trasformabile a pavimento tramite curva tecnica.

BTW NO-RIM wc with wall trap changeable into floor trap by technical bend.

- Kg 26
- cm 53x36xh 42
- Pz./Pallet 15

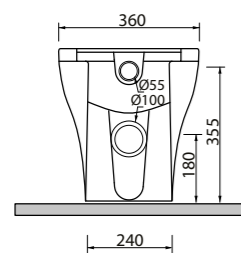
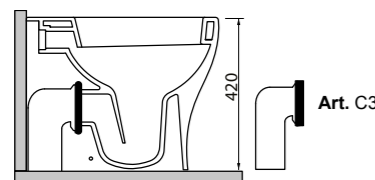
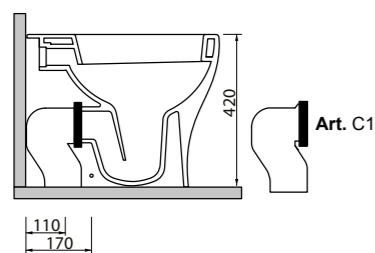
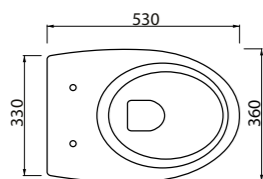

**INSTALLAZIONE TRASLATA
FLOOR DRAIN ADJUSTABLE FLUSH**

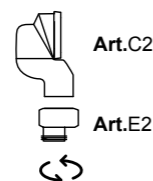
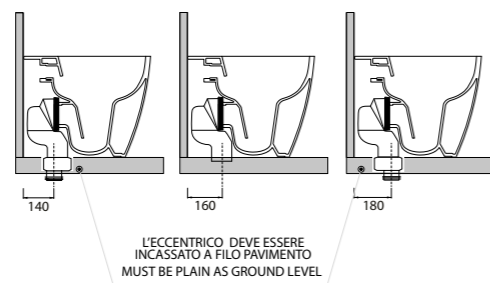

Cod. C1

Raccordo per scarico pavimento. Elbow pipe for floor drain.

- Kg 0,5

Cod. C2

Curva tecnica per scarico traslato. Special elbow pipe for traslated outlet.

- Kg 0,5

Cod C3

Curva tecnica per scarico arretrato. Special elbow pipe for backward outlet.

- Kg 0,5

Cod. E2

Raccordo eccentrico. Eccentric fitting.

- Kg 0,5



Cod. BDF

Bidet monoforo a terra. BTW single hole bidet.

- Kg 23
- cm 53x36xh 42
- Pz./Pallet 15

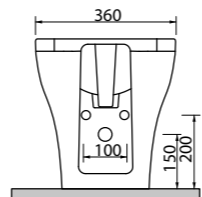
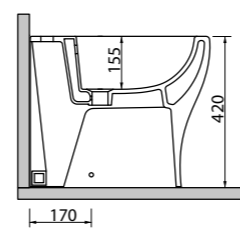
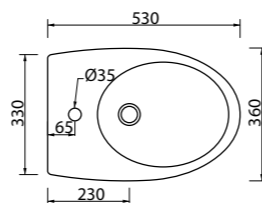

**INSTALLAZIONE
INSTALLATION**

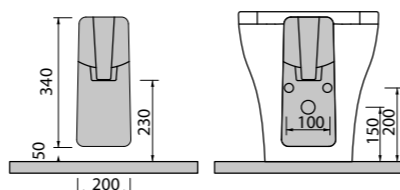

N.B.: Le misure indicate possono subire una variazione dello 0,8 % circa, dovuta ad usura degli stampi o a piccole variazioni delle caratteristiche tecniche relative alle materie prime che compongono l'impasto.
N.B.: The measures indicated may undergo a variation of about 0,8%, due to wear of the molds or to small variations in the technical characteristics of the raw materials that make up the mixture.



Cod. WCSF

Vaso sospeso NO-RIM con fissaggio a scomparsa.

Wall-hung NO-RIM wc with hidden fixing.

- Kg 23
- cm 53x36xh 37
- Pz./Pallet 15

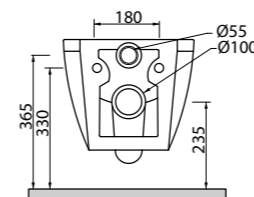
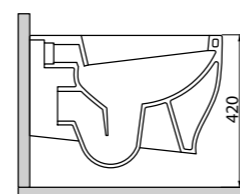
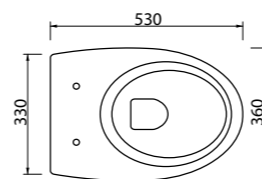

Cod. BDSF

Bidet sospeso monoforo con fissaggio a scomparsa.

Single hole wall-hung bidet with hidden fixing.

- Kg 19
- cm 53x36xh 32,5
- Pz./Pallet 15

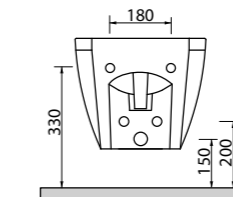
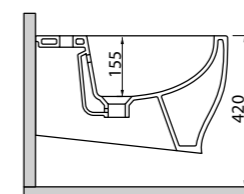
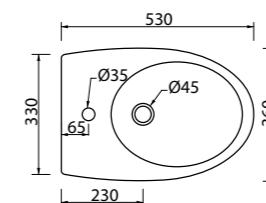

**INSTALLAZIONE
INSTALLATION**

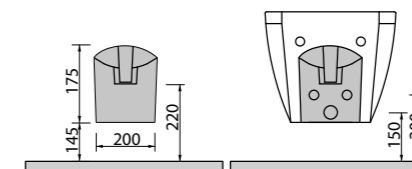

Cod. CWF

Coprivaso in termindurente con cerniera a sgancio rapido.

Quick-release thermoset seat cover.

- Kg 2,5
- Pz./Pallet 150



Cod. CWFS

Coprivaso soft close in termindurente con cerniera a sgancio rapido.

Soft close quick-release thermoset seat cover.

- Kg 2,5
- Pz./Pallet 150



Cod. L1

Sistema universale a L per sanitari sospesi. Universal L-shaped fixing system wall-hung wc/bidet.

- Kg 1,5



Cod T1

Raccordo per scarico a parete. Pipe for wall drain.

- Kg 0,2



Cod. P1

Protezione e guarnizione antirumore. Acoustic and crash protection pad for sanitaryware.

- Kg 0,1

#BULL500

254



Cod. WCB5R

Vaso NO-RIM con scarico a parete trasformabile a pavimento tramite curva tecnica.

BTW NO-RIM wc with wall trap changeable into floor trap by technical bend.

- Kg 25
- cm 50x38,3xh 42
- Pz./Pallet 15

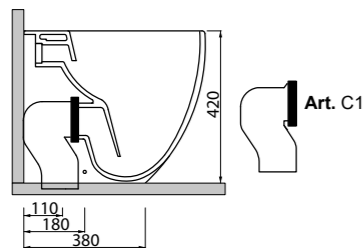
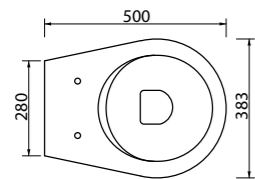

Art. C1

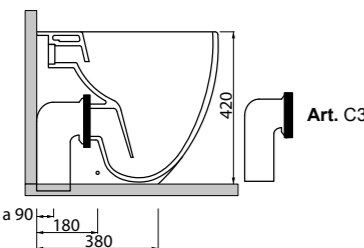

Art. C3

da 60 a 90

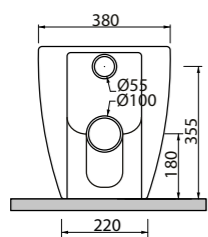

INSTALLAZIONE TRASLATATA FLOOR DRAIN ADJUSTABLE FLUSH

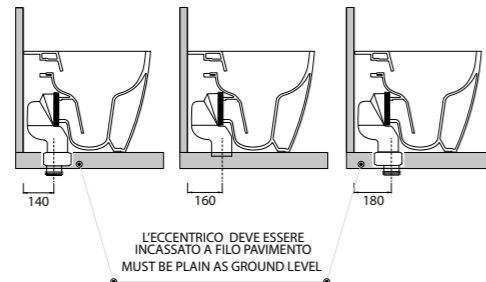

L'ECCENTRICO DEVE ESSERE
INCASSATO A FILO PAVIMENTO
MUST BE PLAIN AS GROUND LEVEL

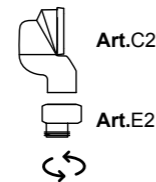

Art. C2

Art. E2

Cod. C1

Raccordo per scarico pavimento.
Elbow pipe for floor drain.

- Kg 0,5

Cod. C2

Curva tecnica per scarico traslato.
Special elbow pipe for traslated outlet.

- Kg 0,5

Cod C3

Curva tecnica per scarico arretrato.
Special elbow pipe for backward outlet.

- Kg 0,5

Cod. E2

Raccordo eccentrico.
Eccentric fitting.

- Kg 0,5



Cod. BDB500

Bidet monoforo a terra.
BTW single hole bidet.

- Kg 23
- cm 50x38,3xh 42
- Pz./Pallet 15

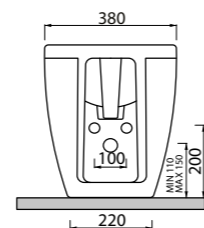
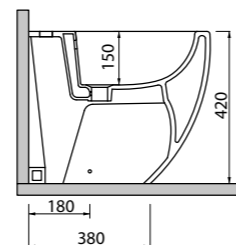
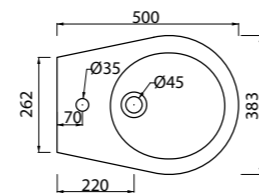

INSTALLAZIONE INSTALLATION

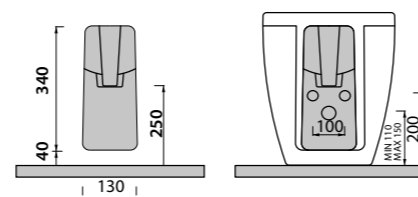

Cod. WCSB5R

Vaso sospeso NO-RIM con fissaggio a scomparsa.

Wall-hung NO-RIM wc with hidden fixing.

- Kg 23
- cm 53x36xh 37
- Pz./Pallet 15

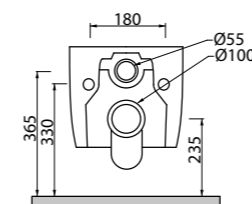
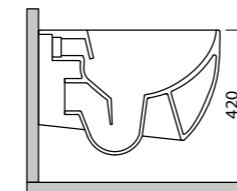
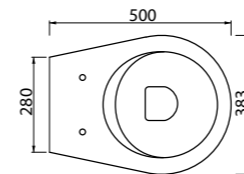

Cod. BDSB500

Bidet sospeso monoforo con fissaggio a scomparsa.

Single hole wall-hung bidet with hidden fixing.

- Kg 18
- cm 53x36xh 33
- Pz./Pallet 15

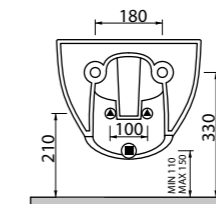
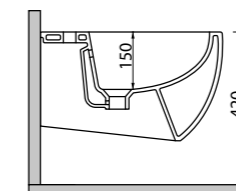
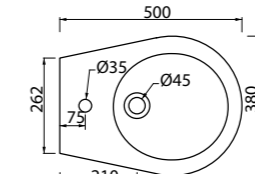

INSTALLAZIONE INSTALLATION

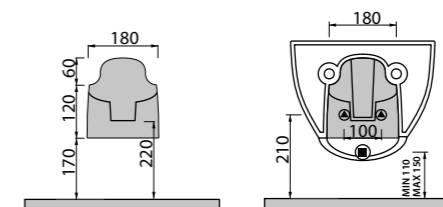

255



Cod. CWB5R

Coprivaso in termidurente con cerniera a sgancio rapido.

Quick-release thermoset seat cover.

- Kg 2,5
- Pz./Pallet 150



Cod. CWB5RF

Coprivaso soft close in termidurente con cerniera a sgancio rapido.

Soft close quick-release thermoset seat cover.

- Kg 2,5
- Pz./Pallet 150



Cod. L1

Sistema universale a L per sanitari sospesi.
Universal L-shaped fixing system wall-hung wc/bidet.

- Kg 1,5



Cod T1

Raccordo per scarico a parete.
Pipe for wall drain.

- Kg 0,2



Cod. P1

Protezione e guarnizione antirumore.
Acoustic and crash protection pad for sanitaryware.

- Kg 0,1

#REVOLUTION

256



Cod. 1.WCSR

Vaso sospeso NO-RIM con fissaggio a scomparsa.

Wall-hung NO-RIM wc with hidden fixing.

- Kg 24
- cm 53x36xh 37
- Pz./Pallet 15

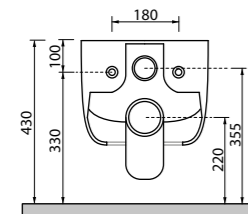
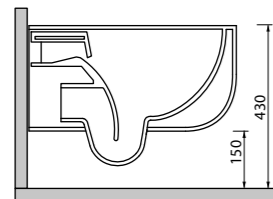
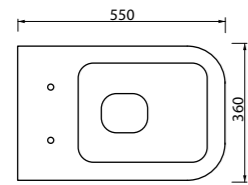

Cod. 1.BDSR

Bidet sospeso monoforo con fissaggio a scomparsa.

Single hole wall-hung bidet with hidden fixing.

- Kg 18
- cm 53x36xh 28
- Pz./Pallet 15

Cod. PLR

Piletta click-clack universale con adattatore per scarico libero in ottone cromato e tappo in Livin-Stone® (Solid Surface)

Universal click-clack drain with adapter for free drain in chromed brass with Livin-Stone® (Solid Surface) cap

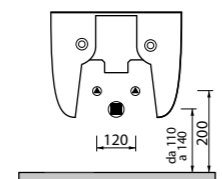
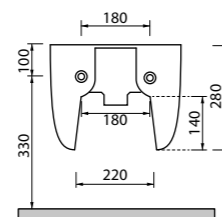
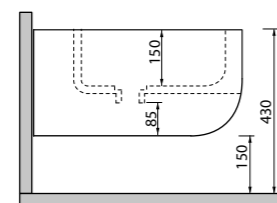
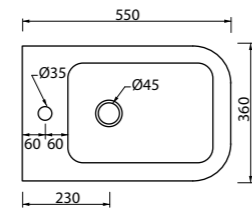

Cod. 1.CWR

Coprivaso soft close in termindurente con cerniera a sgancio rapido.

Soft close quick-release thermoset seat cover.

- Kg 2,5
- Pz./Pallet 150



Cod. L1

Sistema universale a L per sanitari sospesi.

Universal L-shaped fixing system wall-hung wc/bidet.

- Kg 1,5



Cod T1

Raccordo per scarico a parete. Pipe for wall drain.

- Kg 0,2



Cod. P1

Protezione e guarnizione antirumore.

Acoustic and crash protection pad for sanitaryware.

- Kg 0,1

257

#CERAMICA Lavabi d'arredo/Washbasins

258

POOL 1



Cod. LVP1

Lavabo 42x42 installabile esclusivamente in appoggio senza troppopieno.

42x42 washbasin to install exclusively sitted on, No overflow.

- Kg 8
- cm 42x42xh 17,5
- Pz./Pallet 24

Cod WPIL

Piletta click-clack universale con adattatore per scarico libero in ottone cromato e tappo ceramica.

Universal click-clack drain with adapter for free drain in chromed brass with ceramic cap.

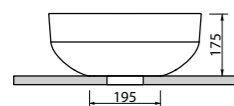
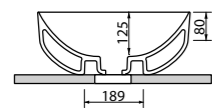
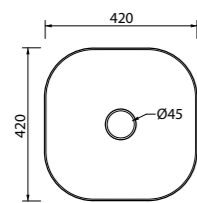

POOL 2



Cod. LVP2

Lavabo 62x42 installabile esclusivamente in appoggio senza troppopieno.

62x42 washbasin to install exclusively sitted on, No overflow.

- Kg 12
- cm 62x42xh 17,5
- Pz./Pallet 24

Cod WPIL

Piletta click-clack universale con adattatore per scarico libero in ottone cromato e tappo ceramica.

Universal click-clack drain with adapter for free drain in chromed brass with ceramic cap.

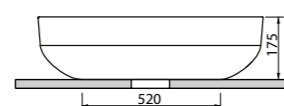
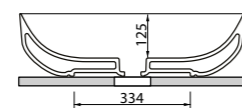
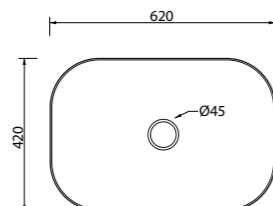

POOL 3



Cod. LVP3

Lavabo monoforo 42x47, installabile sospeso.

42x47 single hole washbasin can be installed wall hung.

- Kg XX
- cm 42x47xh 17,5
- Pz./Pallet 24

Cod WPIL

Piletta click-clack universale con adattatore per scarico libero in ottone cromato e tappo ceramica.

Universal click-clack drain with adapter for free drain in chromed brass with ceramic cap.

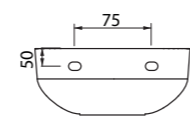
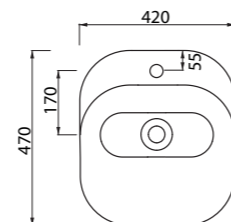

POOL 4



Cod. LVP4

Lavabo monoforo 62x47, installabile sospeso.

62x47 single hole washbasin can be installed wall hung.

- Kg XX
- cm 62x47xh 17,5
- Pz./Pallet 24

Cod WPIL

Piletta click-clack universale con adattatore per scarico libero in ottone cromato e tappo ceramica.

Universal click-clack drain with adapter for free drain in chromed brass with ceramic cap.

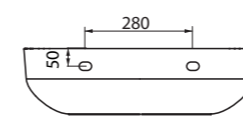
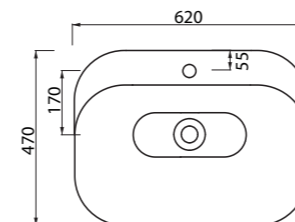

POOL 5



Cod. LVP5

Lavabo monoforo 92x47, installabile sospeso.

92x47 single hole washbasin can be installed wall hung.

- Kg XX
- cm 92x47xh 17,5
- Pz./Pallet 24

Cod WPIL

Piletta click-clack universale con adattatore per scarico libero in ottone cromato e tappo ceramica.

Universal click-clack drain with adapter for free drain in chromed brass with ceramic cap.

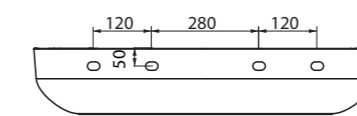
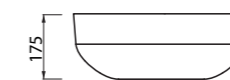
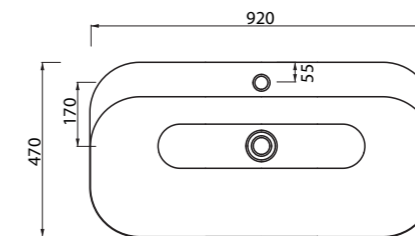

LAKE 1



Cod. LVL1

Lavabo Ø42 installabile esclusivamente in appoggio senza troppopieno.

Ø42 washbasin to install exclusively sitted on, No overflow.

- Kg XX
- cm Ø42xh 17,5
- Pz./Pallet 24

Cod WPIL

Piletta click-clack universale con adattatore per scarico libero in ottone cromato e tappo ceramica.

Universal click-clack drain with adapter for free drain in chromed brass with ceramic cap.

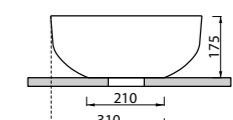
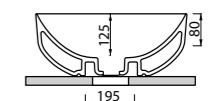
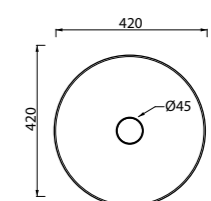

259

#CERAMICA Lavabi d'arredo/Washbasins

N.B.: Le misure indicate possono subire una variazione dello 0.8 % circa, dovuta ad usura degli stampi o a piccole variazioni delle caratteristiche tecniche relative alle materie prime che compongono l'impasto.
N.B.: The measures indicated may undergo a variation of about 0.8%, due to wear of the molds or to small variations in the technical characteristics of the raw materials that make up the mixture.

260

LAKE 2



Cod. LVL2

Lavabo 60x42 installabile esclusivamente in appoggio senza troppopieno.

60x42 washbasin to install exclusively sitted on, No overflow.

- Kg XX
- cm 60x42xh 17,5
- Pz./Pallet 24

Cod WPIL

Piletta click-clack universale con adattatore per scarico libero in ottone cromato e tappo ceramica.

Universal click-clack drain with adapter for free drain in chromed brass with ceramic cap.

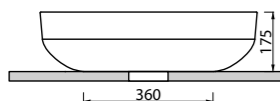
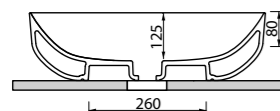
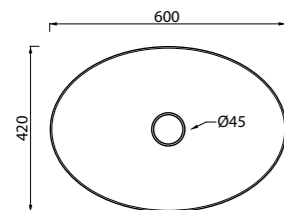

QUBE 1



Cod. LVQ1

Lavabo 44x44 installabile esclusivamente in appoggio senza troppopieno.

44x44 washbasin to install exclusively sitted on, No overflow.

- Kg 10
- cm 44x44xh 14
- Pz./Pallet 24

Cod WPIL

Piletta click-clack universale con adattatore per scarico libero in ottone cromato e tappo ceramica.

Universal click-clack drain with adapter for free drain in chromed brass with ceramic cap.

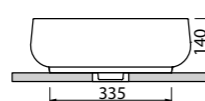
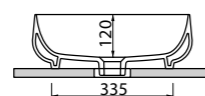
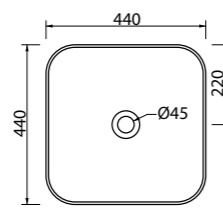

QUBE 2



Cod. LVQ2

Lavabo monoforo 44x44, installabile sospeso o in appoggio.

44x44 single hole washbasin can be installed wall hung or sitted on.

- Kg 12
- cm 44x44xh 14
- Pz./Pallet 24

Cod WPIL

Piletta click-clack universale con adattatore per scarico libero in ottone cromato e tappo ceramica.

Universal click-clack drain with adapter for free drain in chromed brass with ceramic cap.

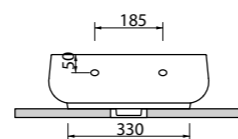
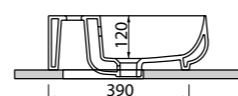
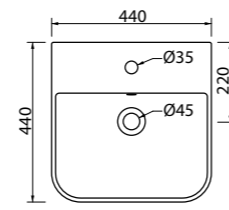

QUBE 3



Cod. LVQ3

Lavabo 62x44 installabile esclusivamente in appoggio senza troppopieno.

62x44 washbasin to install exclusively sitted on, no overflow.

- Kg 15
- cm 62x44xh 14
- Pz./Pallet 24

Cod WPIL

Piletta click-clack universale con adattatore per scarico libero in ottone cromato e tappo ceramica.

Universal click-clack drain with adapter for free drain in chromed brass with ceramic cap.

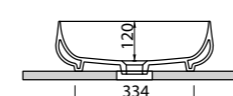
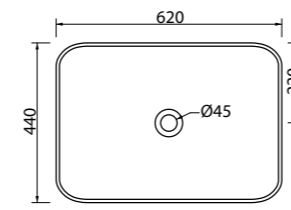

QUBE 4



Cod. LVQ4

Lavabo monoforo 62x44, installabile sospeso o in appoggio.

62x44 single hole washbasin can be installed wall hung or sitted on.

- Kg 18
- cm 62x44xh 14
- Pz./Pallet 24

Cod WPIL

Piletta click-clack universale con adattatore per scarico libero in ottone cromato e tappo ceramica.

Universal click-clack drain with adapter for free drain in chromed brass with ceramic cap.

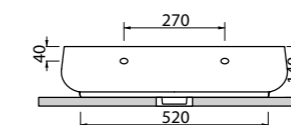
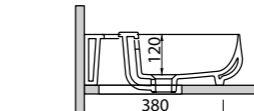
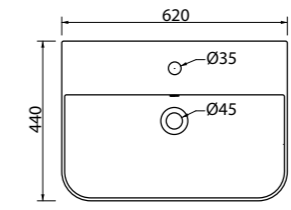

QUBE 5



Cod. LVQ5

Lavabo 75x44 installabile esclusivamente in appoggio senza troppopieno.

75x44 washbasin to install exclusively sitted on, no overflow.

- Kg 17
- cm 75x44xh 14
- Pz./Pallet 18

Cod WPIL

Piletta click-clack universale con adattatore per scarico libero in ottone cromato e tappo ceramica.

Universal click-clack drain with adapter for free drain in chromed brass with ceramic cap.

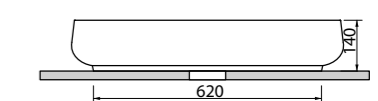
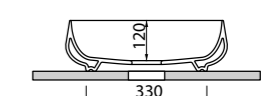
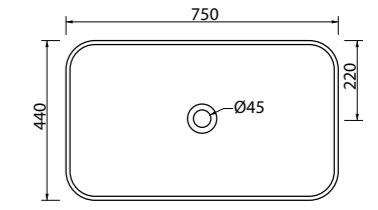

261

#CERAMICA Lavabi d'arredo/Washbasins

N.B.: Le misure indicate possono subire una variazione dello 0,8 % circa, dovuta ad usura degli stampi o a piccole variazioni delle caratteristiche tecniche relative alle materie prime che compongono l'impasto.
 N.B.: The measures indicated may undergo a variation of about 0.8%, due to wear of the molds or to small variations in the technical characteristics of the raw materials that make up the mixture.

262

QUBE 11



Cod. LVQ11

Lavabo 50x33 installabile esclusivamente in appoggio senza troppopieno.

50x33 washabsin to install exclusively sitted on, no overflow.

- Kg 9,5
- cm 50x33xh12
- Pz./Pallet 24

Cod WPIL

Piletta click-clack universale con adattatore per scarico libero in ottone cromato e tappo ceramica.

Universal click-clack drain with adapter for free drain in chromed brass with ceramic cap.

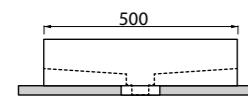
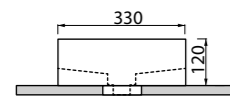
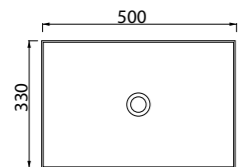

FLAT 1



Cod. LVF1

Lavabo da appoggio Ø 42 senza troppopieno.

Ø 42 sit on washbasin without overflow.

- Kg 8
- cm Ø42xh 16
- Pz./Pallet 24

Cod WPIL

Piletta click-clack universale con adattatore per scarico libero in ottone cromato e tappo ceramica.

Universal click-clack drain with adapter for free drain in chromed brass with ceramic cap.

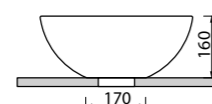
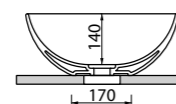
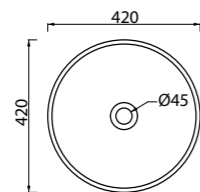

FLAT 2



Cod. LVF2

Lavabo da appoggio 60x40 senza troppopieno.

60x40 sit on washabsin without overflow.

- Kg 10
- cm 60x40xh 13
- Pz./Pallet 24

Cod WPIL

Piletta click-clack universale con adattatore per scarico libero in ottone cromato e tappo ceramica.

Universal click-clack drain with adapter for free drain in chromed brass with ceramic cap.

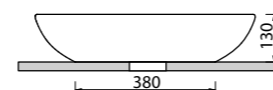
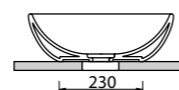
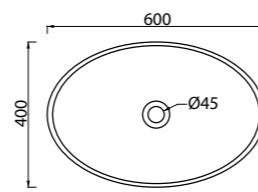

FLAT 3



Cod. LVF3

Lavabo da appoggio 70x41 senza troppopieno.

70x41 sit on washabsin without overflow.

- Kg 13
- cm 70x41xh 13
- Pz./Pallet 13

Cod WPIL

Piletta click-clack universale con adattatore per scarico libero in ottone cromato e tappo ceramica.

Universal click-clack drain with adapter for free drain in chromed brass with ceramic cap.

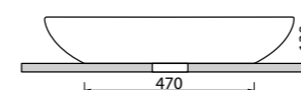
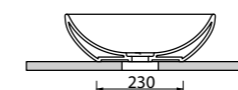
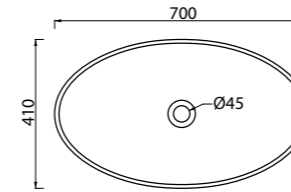

FLAT 4



Cod. LVF4

Lavabo monoforo 70x54, installabile sospeso o in appoggio.

70x54 single hole washbasin can be installed wall hung or sitted on.

- Kg 19
- cm 70x54xh 15
- Pz./Pallet 18

Cod WPIL

Piletta click-clack universale con adattatore per scarico libero in ottone cromato e tappo ceramica.

Universal click-clack drain with adapter for free drain in chromed brass with ceramic cap.

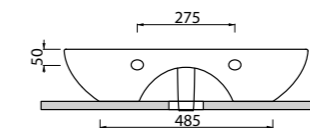
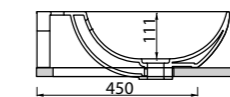
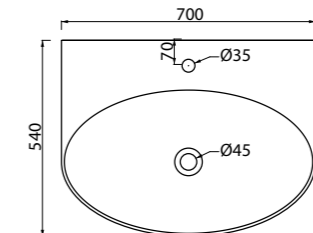

263

FLAT 5



Cod. LVF5

Lavabo monolitico Ø42 h 88, in ceramica, compreso raccordo di scarico. Scarico a terra.

Ceramic Ø42 h88 free standing washbasin, outlet connector included. Floor drain.

- Kg 44
- cm Ø42xh 88
- Pz./Pallet 4

Cod WPIL

Piletta click-clack universale con adattatore per scarico libero in ottone cromato e tappo ceramica.

Universal click-clack drain with adapter for free drain in chromed brass with ceramic cap.

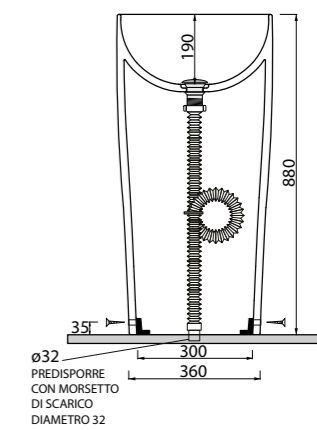

#REVOLUTION Lavabi d'arredo/Washbasins

264 **FLAT 5**



Cod. LVF5/P

Lavabo monolitico Ø42 h 88, in ceramica, compreso raccordo di scarico. Scarico a parete.

Ceramic Ø42 h88 free standing washbasin, outlet connector included. Wall drain.

- Kg 44
- cm Ø42xh 88
- Pz./Pallet 4

Cod WPIL

Piletta click-clack universale con adattatore per scarico libero in ottone cromato e tappo ceramica.

Universal click-clack drain with adapter for free drain in chromed brass with ceramic cap.

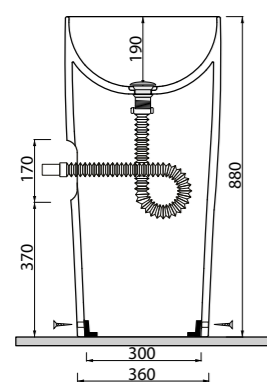

REVOLUTION75



Cod. LVR7

Consolle Revolution 75x48, installabile sospesa o in appoggio.

Revolution 75x48 console can be installed wall hung or sitted on.

- Kg 22
- cm 75x48xh 13
- Pz./Pallet 10

Cod WPIL

Piletta click-clack universale con adattatore per scarico libero in ottone cromato e tappo ceramica.

Universal click-clack drain with adapter for free drain in chromed brass with ceramic cap.

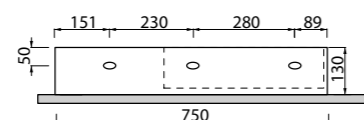
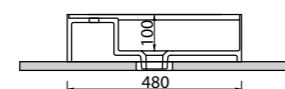
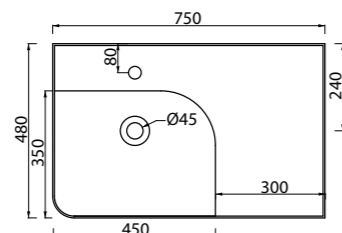

REVOLUTION95



Cod. LVR

Consolle Revolution 95x48, installabile sospesa o in appoggio.

Revolution 95x48 console can be installed wall hung or sitted on.

- Kg 27,5
- cm 95x48xh 13
- Pz./Pallet 10

Cod WPIL

Piletta click-clack universale con adattatore per scarico libero in ottone cromato e tappo ceramica.

Universal click-clack drain with adapter for free drain in chromed brass with ceramic cap.

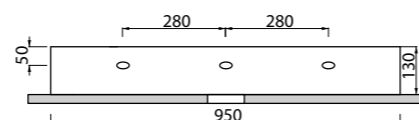
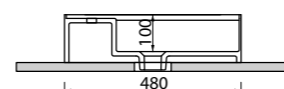
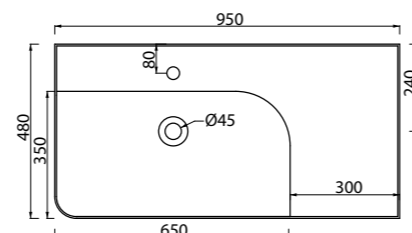

265

N.B.: Le misure indicate possono subire una variazione dello 0.8 % circa, dovuta ad usura degli stampi o a piccole variazioni delle caratteristiche tecniche relative alle materie prime che compongono l'impasto.
 N.B.: The measures indicated may undergo a variation of about 0.8%, due to wear of the molds or to small variations in the technical characteristics of the raw materials that make up the mixture.

#LIVIN-STONE® Lavabi d'arredo/Washbasins

266

FLAT 7



Cod. LVF7

Lavabo da appoggio Ø39 in Livin-Stone® (Solid Surface).

Livin-Stone® (Solid Surface) Ø39 sit-on washbasin.

- Kg 5
- cm Ø39xh 11,5
- Pz./Pallet 24

Cod. PIL

Piletta click-clack universale con adattatore per scarico libero in ottone cromato e tappo in tono.

Universal click-clack drain with adapter for free drain in chromed brass with cap in tone.

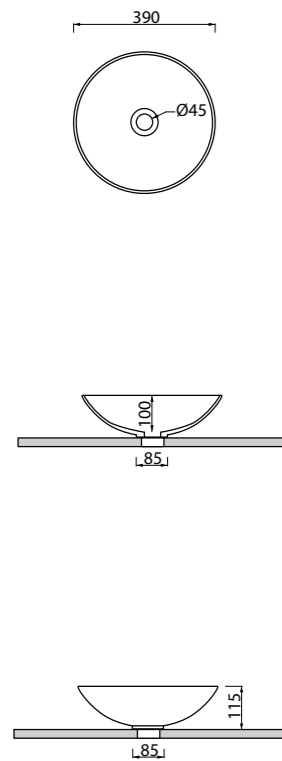

FLAT 8



Cod. LVF8

Lavabo da appoggio 60x42 in Livin-Stone® (Solid Surface).

Livin-Stone® (Solid Surface) 60x42 sit-on washbasin.

- Kg 13
- cm 60x42xh 13,5
- Pz./Pallet 27

Cod. PLV

Piletta click-clack universale con adattatore per scarico libero in ottone cromato e tappo in Livin-Stone® (Solid Surface).

Universal click-clack drain with adapter for free drain in chromed brass with Livin-Stone® (Solid Surface) cap.

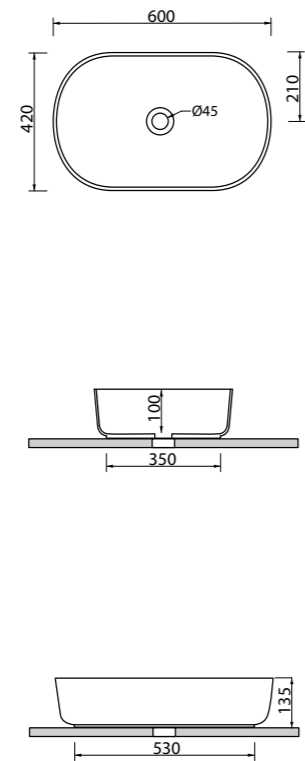

FLAT 9



Cod. LVF9

Lavabo da appoggio Ø42 in Livin-Stone® (Solid Surface).

Livin-Stone® (Solid Surface) Ø42 sit-on washbasin.

- Kg 16
- cm Ø42xh 30
- Pz./Pallet 12

Cod. PLV

Piletta click-clack universale con adattatore per scarico libero in ottone cromato e tappo in Livin-Stone® (Solid Surface).

Universal click-clack drain with adapter for free drain in chromed brass with Livin-Stone® (Solid Surface) cap.

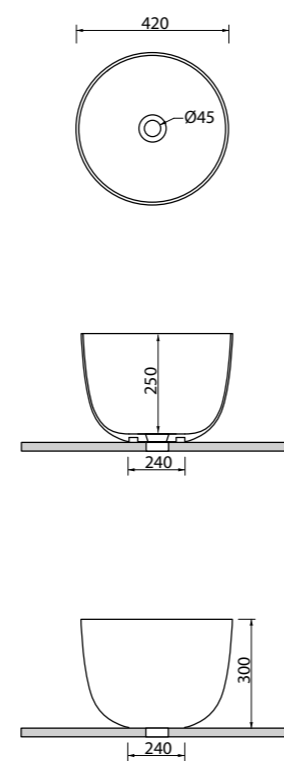

QUBE 9



Cod. LVQ9

Lavabo da appoggio 60x42 in Livin-Stone® (Solid Surface).

Livin-Stone® (Solid Surface) 60x42 sit-on washbasin.

- Kg 13
- cm 60x42xh 13,5
- Pz./Pallet 27

Cod. PLV

Piletta click-clack universale con adattatore per scarico libero in ottone cromato e tappo in Livin-Stone® (Solid Surface).

Universal click-clack drain with adapter for free drain in chromed brass with Livin-Stone® (Solid Surface) cap.

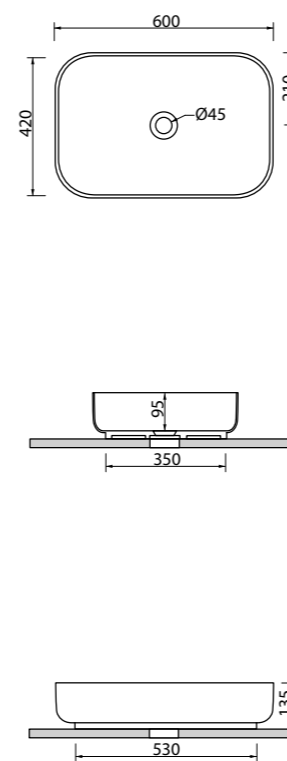

QUBE 10



Cod. LVQ10

Lavabo da appoggio 42x42 in Livin-Stone® (Solid Surface).

Livin-Stone® (Solid Surface) 42x42 sit-on washbasin.

- Kg 16
- cm 42x42xh 30
- Pz./Pallet 12

Cod. PLV

Piletta click-clack universale con adattatore per scarico libero in ottone cromato e tappo in Livin-Stone® (Solid Surface).

Universal click-clack drain with adapter for free drain in chromed brass with Livin-Stone® (Solid Surface) cap.

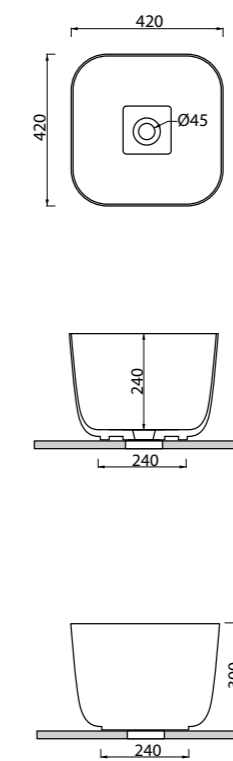

QUBE 12



Cod. LVQ12

Lavabo da appoggio 50x33 in Livin-Stone® (Solid Surface).

Livin-Stone® (Solid Surface) 50x33 sit-on washbasin.

- Kg xx
- cm 50x33xh 12
- Pz./Pallet xx

Cod. PLV

Piletta click-clack universale con adattatore per scarico libero in ottone cromato e tappo in Livin-Stone® (Solid Surface).

Universal click-clack drain with adapter for free drain in chromed brass with Livin-Stone® (Solid Surface) cap.

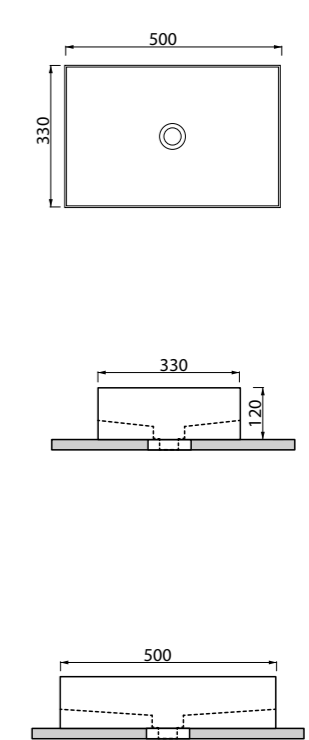

267

#LIVIN-STONE® Lavabi d'arredo/Washbasins

268

FLAT 6



Cod. LVF6

Lavabo monolitico Ø44 h 82, in Livin-Stone® (Solid Surface).

Livin-Stone® (Solid Surface) Ø44 h 82 free standing washbasin.

- Kg 25
- cm Ø44xh 82
- Pz./Pallet 4

Cod. PLV

Piletta click-clack universale con adattatore per scarico libero in ottone cromato e tappo in Livin-Stone® (Solid Surface).

Universal click-clack drain with adapter for free drain in chromed brass with Livin-Stone® (Solid Surface) cap.

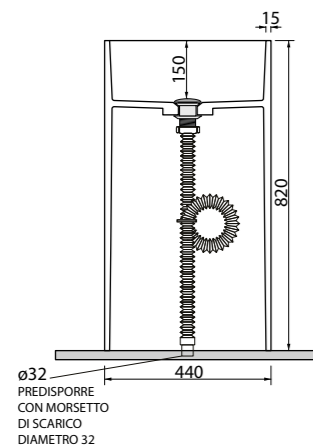
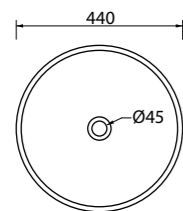

QUBE 7



Cod. LVQ7

Lavabo monolitico 44x44 h 82, in Livin-Stone® (Solid Surface), compreso raccordo di scarico.

Livin-Stone® (Solid Surface) 44x44 h 82 free standing washbasin, outlet connector included.

- Kg 25
- cm 44x44xh 82
- Pz./Pallet 4

Cod. PLV

Piletta click-clack universale con adattatore per scarico libero in ottone cromato e tappo in Livin-Stone® (Solid Surface).

Universal click-clack drain with adapter for free drain in chromed brass with Livin-Stone® (Solid Surface) cap.

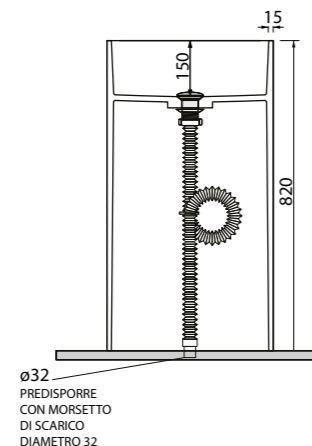
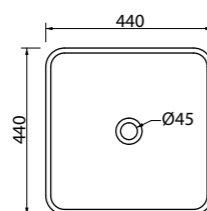

QUBE 8



Cod. LVQ7

Lavabo monolitico 48x42 h 85, in Livin-Stone® (Solid Surface), compreso raccordo di scarico.

Livin-Stone® (Solid Surface) 48x42 h 85 free standing washbasin, outlet connector included.

- Kg 25
- cm 48x42xh 85
- Pz./Pallet 4

Cod. PLV

Piletta click-clack universale con adattatore per scarico libero in ottone cromato e tappo in Livin-Stone® (Solid Surface).

Universal click-clack drain with adapter for free drain in chromed brass with Livin-Stone® (Solid Surface) cap.

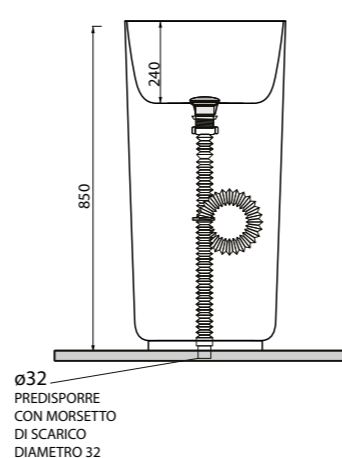
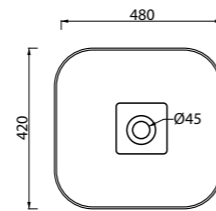

#VASCHE Free-standing / Free-standing Bathtubs

269

VASCA BULL



Cod. VBL

Vasca BULL in Livin-Stone® (Solid Surface).

BULL Livin-Stone® (Solid Surface) bath tube.

- Kg 105
- cm 169x87xh 53
- Pz./Pallet 1
- Mis. Pallet 190x98xh 80

Cod. PVBL

Sifone e piletta di scarico con copripiletta.

Plug cover + siphon.

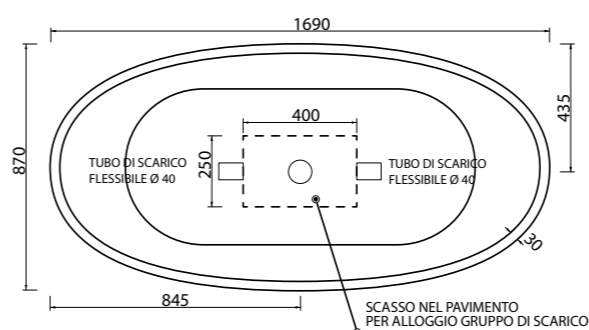
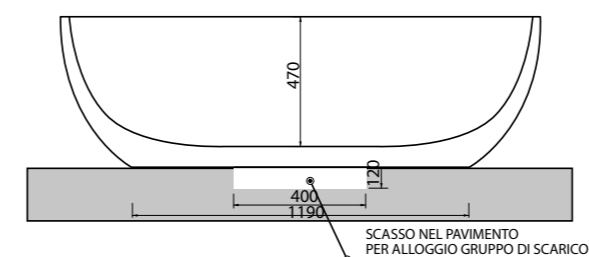
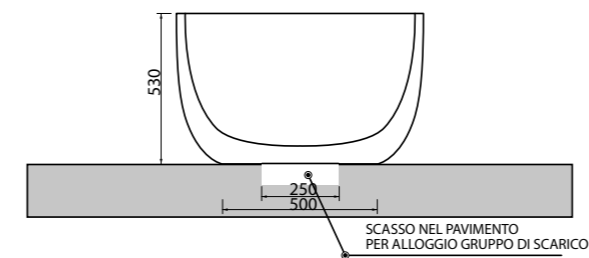

VASCA QUADRA



Cod. VQD

Vasca QUADRA in Livin-Stone® (Solid Surface).

QUADRA Livin-Stone® (Solid Surface) bath tube.

- Kg 100
- cm 170x77xh 59
- Pz./Pallet 1
- Mis. Pallet 190x98xh 80

Cod. PVQD

Sifone e piletta di scarico con copripiletta.

Plug cover + siphon.

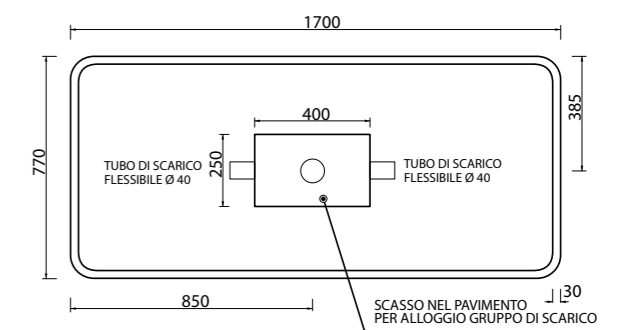
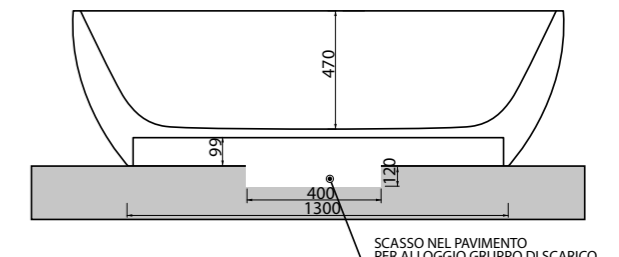
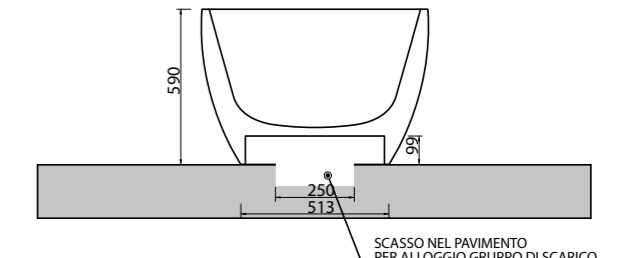

#VASCHE Free-standing / Free-standing Bathtubs

270

VASCA OVALE REVOLUTION



Cod. VR

Vasca OVALE REVOLUTION in Livin-Stone® (Solid Surface).

OVAL REVOLUTION Livin-Stone® (Solid Surface) bath tube.

- Kg 105
- cm 170x80xh 50
- Pz./Pallet 1
- Mis. Pallet 190x98xh80

Cod. PVR

Sifone e piletta di scarico con copripiletta.

Plug cover + siphon.

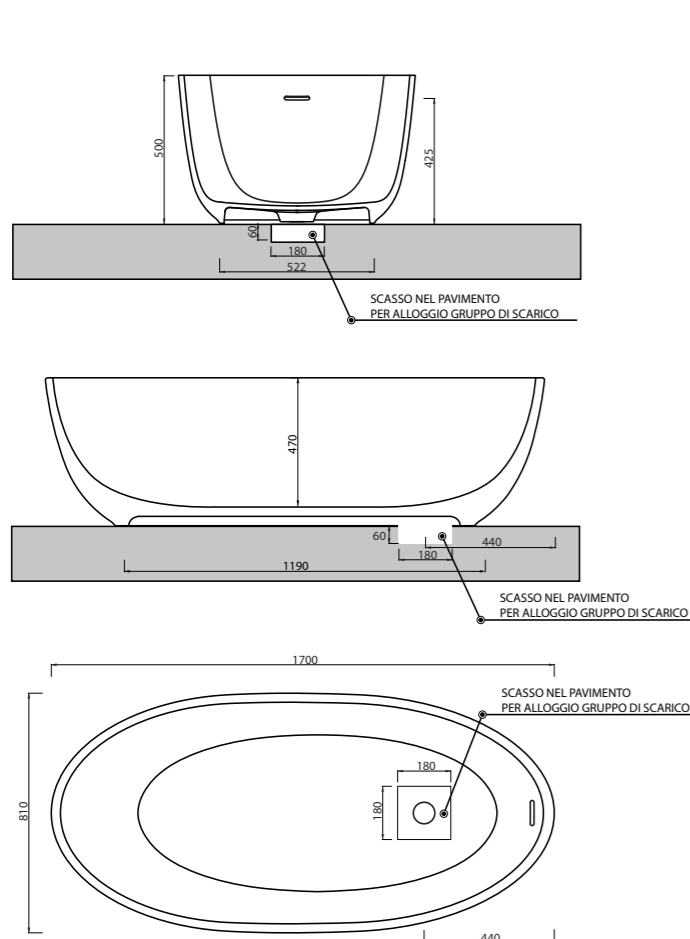

VASCA QUADRA REVOLUTION



Cod. VQR

Vasca QUADRA REVOLUTION in Livin-Stone® (Solid Surface).

QUADRA REVOLUTION Livin-Stone® (Solid Surface) bath tube.

- Kg 105
- cm 170x70xh 50
- Pz./Pallet 1
- Mis. Pallet 190x98xh80

Cod. PVQR

Sifone e piletta di scarico con copripiletta.

Plug cover + siphon.

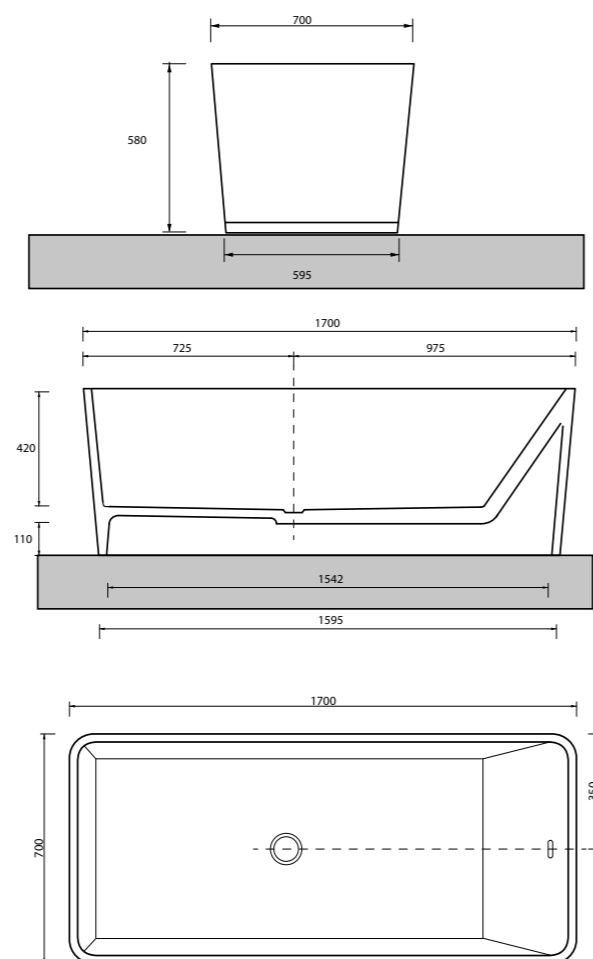

SGABELLO



Cod. SGR

Sgabello in Livin-Stone® (Solid Surface).

Livin-Stone® (Solid Surface) stool.

- Kg 11
- cm 40x30xh 43

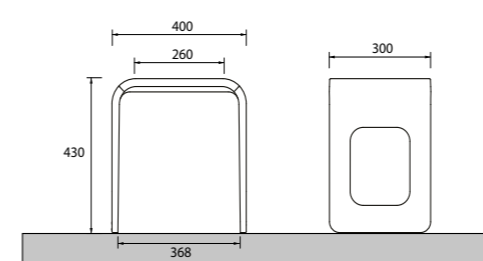

271

#LONGLIFE® Piatti doccia/Shower Trays

#LONGLIFE® Piatti doccia/Shower Trays

272

CERAMICA H 3 CM

N.B.
Incluso nel prezzo: piletta di scarico e copripiletta double face inox/resina.
Included in the price: drain and double-sided stainless steel/resin drain cover.

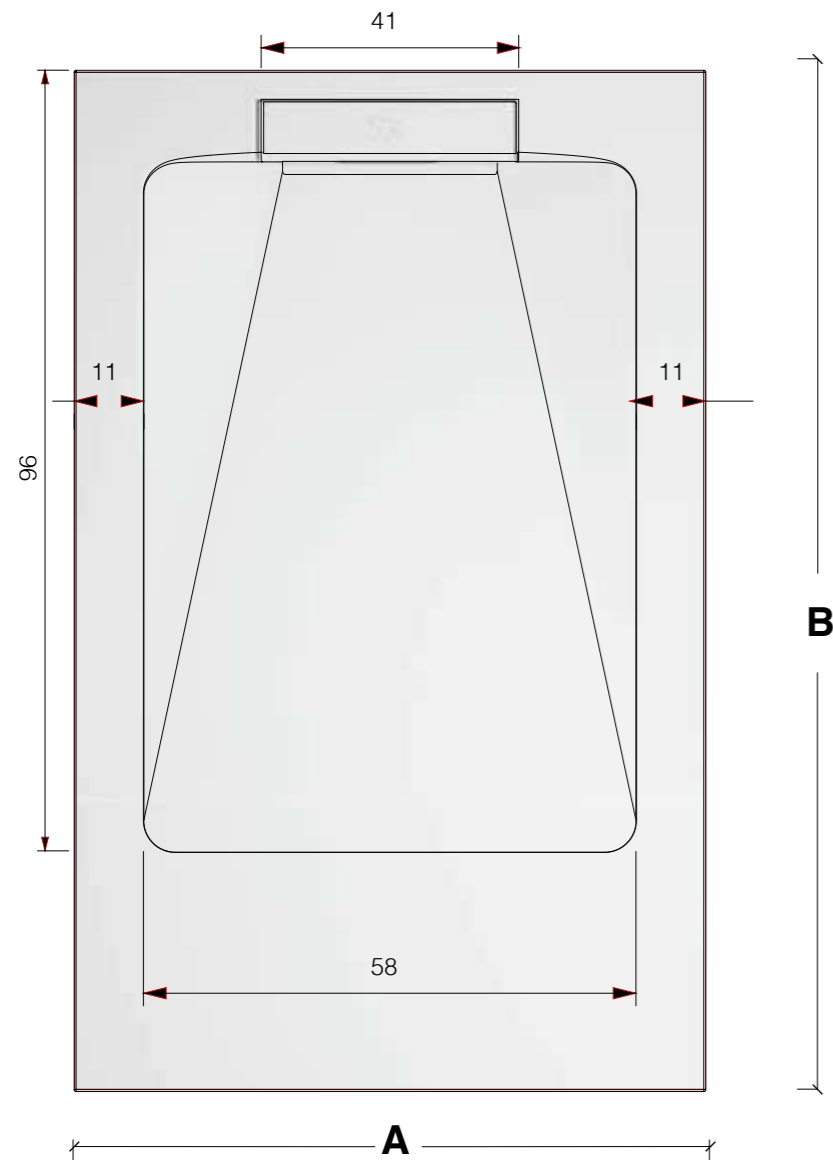

	A	B
LL700	70	100
LL705	70	105
LL710	70	110
LL715	70	115
LL720	70	120
LL725	70	125
LL730	70	130
LL735	70	135
LL740	70	140
LL800	80	100
LL805	80	105
LL810	80	110
LL815	80	115
LL820	80	120
LL825	80	125
LL830	80	130
LL835	80	135
LL840	80	140



273

CERAMICA H 3 CM

N.B.
Incluso nel prezzo: piletta di scarico e copripiletta double face inox/resina.
Included in the price: drain and double-sided stainless steel/resin drain cover.

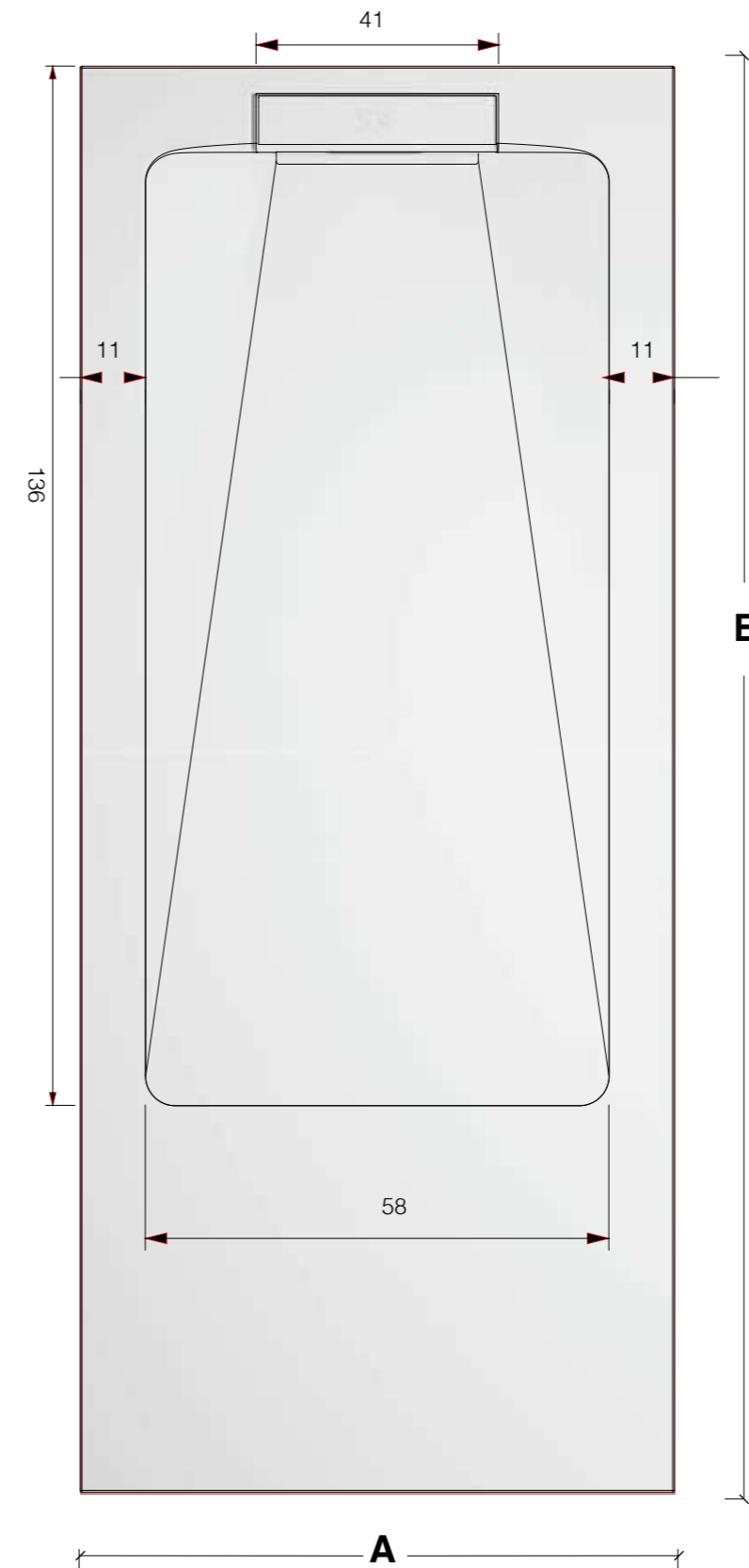

	A	B
LL745	70	145
LL750	70	150
LL755	70	155
LL760	70	160
LL765	70	165
LL770	70	170
LL775	70	175
LL780	70	180
LL845	80	145
LL850	80	150
LL855	80	155
LL860	80	160
LL865	80	165
LL870	80	170
LL875	80	175
LL880	80	180



#ENIGMA Piatti doccia/Shower Trays

274

PIETRALUCE H 2,5 CM

N.B.

Incluso nel prezzo la piletta di scarico e copripiletta in tono.
Drain valve and drain cover included in the price.

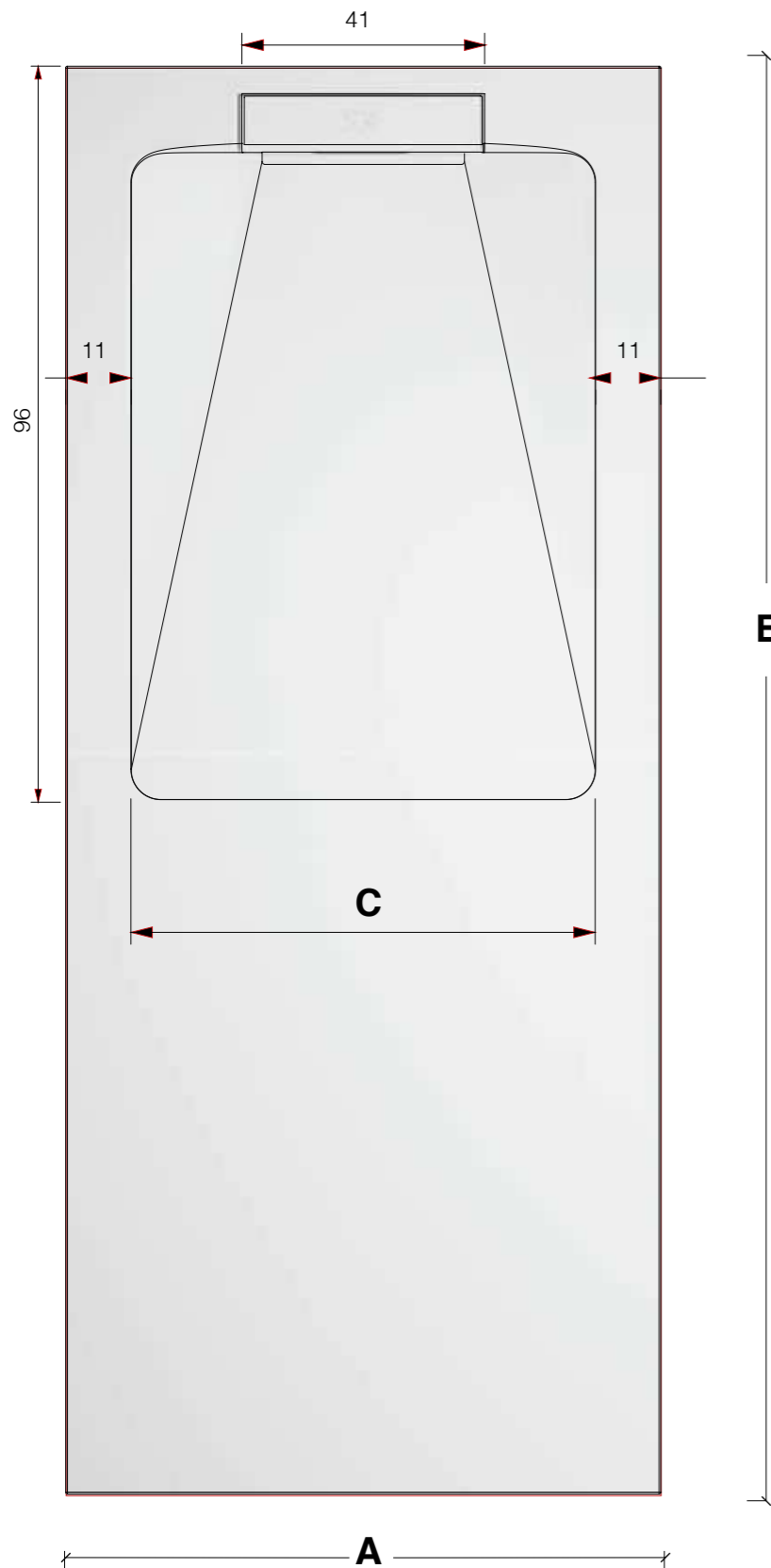

	A	B	C
E710.1	70	100	58
E711.1	70	110	58
E712.1	70	120	58
E713.1	70	130	58
E714.1	70	140	58
E715.1	70	150	58
E716.1	70	160	58
E717.1	70	170	58
E718.1	70	180	58
E719.1	70	190	58
E720.1	70	200	58
E810.1	80	100	58
E811.1	80	110	58
E812.1	80	120	58
E813.1	80	130	58
E814.1	80	140	58
E815.1	80	150	58
E816.1	80	160	58
E817.1	80	170	58
E818.1	80	180	58
E819.1	80	190	58
E820.1	80	200	58
E910.1	90	100	78
E911.1	90	110	78
E912.1	90	120	78
E913.1	90	130	78
E914.1	90	140	78
E915.1	90	150	78
E916.1	90	160	78
E917.1	90	170	78
E918.1	90	180	78
E919.1	90	190	78
E920.1	90	200	78
E1010.1	100	100	78
E1011.1	100	110	78
E1012.1	100	120	78
E1013.1	100	130	78
E1014.1	100	140	78
E1015.1	100	150	78
E1016.1	100	160	78
E1017.1	100	170	78
E1018.1	100	180	78
E1019.1	100	190	78
E1020.1	100	200	78

275

FINITURE DISPONIBILI

Available finishes



MISURE (cm) Sizes		LONGLIFE		ENIGMA	
L	P		Kg		Kg
70	100	●	23	●	22,8
70	105	●	24		
70	110	●	26	●	25,8
70	115	●	27		
70	120	●	29	●	27,1
70	125	●	30		
70	130	●	31	●	31,1
70	135	●	32		
70	140	●	32,5	●	33,3
70	145	●	34		
70	150	●	35,5	●	37,3
70	155	●	36,5		
70	160	●	38	●	39,4
70	165	●	39,5		
70	170	●	42	●	43,4
70	175	●	43		
70	180	●	44,5	●	46,4
70	190	●		●	50,4
70	200	●		●	52,5
80	100	●	28	●	26
80	105	●	39		
80	110	●	31	●	28,5
80	115	●	32		
80	120	●	34	●	31
80	125	●	35		
80	130	●	36	●	34,5
80	135	●	36,5		
80	140	●	37	●	38
80	145	●	39		
80	150	●	40,5	●	41,5
80	155	●	41,5		
80	160	●	43	●	45
80	165	●	44,5		
80	170	●	43,5	●	49
80	175	●	48		
80	180	●	49,5	●	53
80	190	●		●	56,5
80	200	●		●	60
90	100	●		●	31
90	110	●		●	34
90	120	●		●	37
90	130	●		●	40,5
90	140	●		●	44
90	150	●		●	47,5
90	160	●		●	51
90	170	●		●	55,5
90	180	●		●	60
90	190	●		●	68
90	200	●		●	65
100	100	●		●	34,4
100	110	●		●	37,7
100	120	●		●	41,1
100	130	●		●	45
100	140	●		●	44
100	150	●		●	48,8
100	160	●		●	56,6
100	170	●		●	61,6
100	180	●		●	66,6
100	190	●		●	70
100	200	●		●	72,2

#KING Rubinetti lavabo / Washbasin taps

276



Cod. KI1S

Miscelatore monocomando lavabo senza saltarello e scarico

Single lever basin mixer without pop-up waste and drain

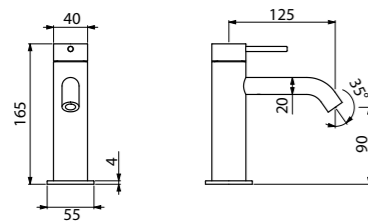

Cod. KI2S

Miscelatore monocomando lavabo medio senza saltarello e scarico

Single lever medium basin mixer without pop-up waste and drain

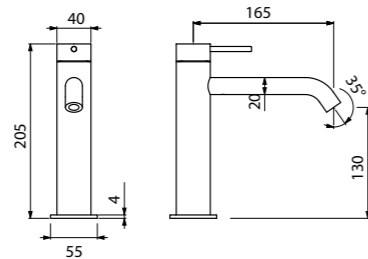

Cod. KI3S

Miscelatore monocomando lavabo rialzato senza saltarello e scarico

Single lever high basin mixer without pop-up waste and drain

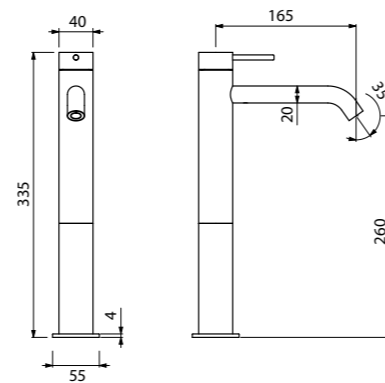

Cod. KI7S

Piantana lavabo senza saltarello e scarico

Floor-standing basin mixer without pop-up waste and drain

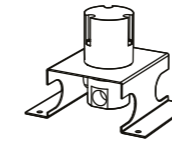

Cod. KINC7

Parte incasso

Built-in Part

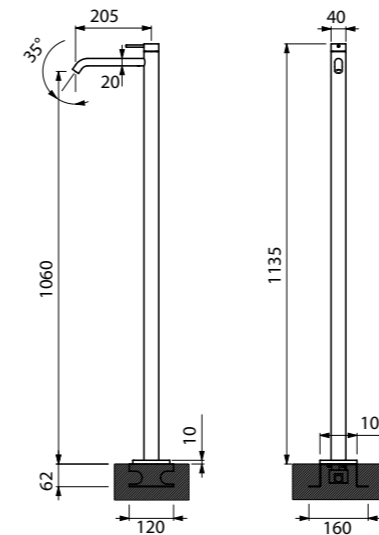

#KING Rubinetti bidet / Bidet taps

277



Cod. KI4S

Miscelatore monocomando bidet senza saltarello e scarico

Single level bidet mixer without pop-up waste and drain

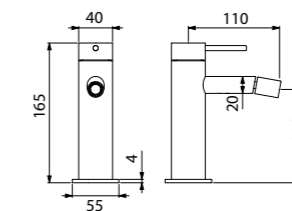

Cod. KCHB50S

Bocca bidet a muro con snodo

Wall-mounted bidet spout with swivel junction

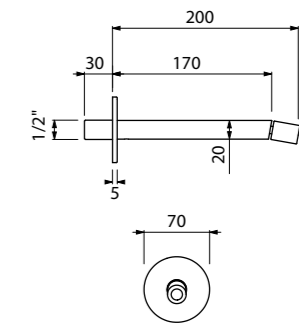

Cod. KI8S

Miscelatore monocomando incasso a parete

Single lever wall-mounted mixer

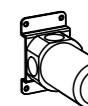

Cod. KINC8S

Miscelatore monocomando incasso a parete (parte incasso)

Single lever wall-mounted mixer (built-in part)

#KING Rubinetti da piano / Counter top taps

278



Cod. KCHT50S

Bocca lavabo top girevole 160° con canna a ponte

Deck-mounted swivel spout (160°) for washbasin with bridge spout



Cod. KI12S

Miscelatore monocomando top

Single lever deck-mounted mixer

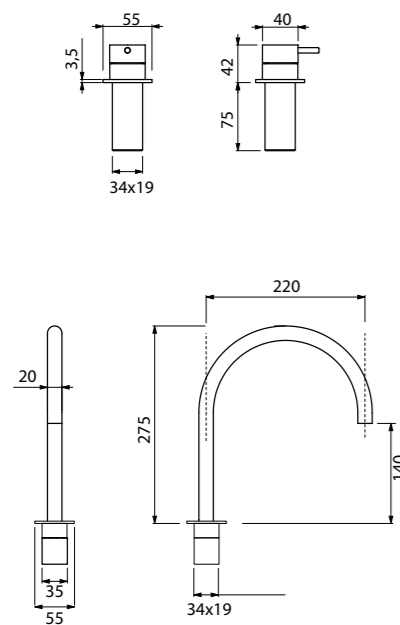

Cod. KCHT51S

Bocca lavabo top girevole (160°) grande con canna a ponte

Big deck-mounted swivel spout (160°) for basin with bridge-shaped spout



Cod. KI12S

Miscelatore monocomando top

Single lever deck-mounted mixer

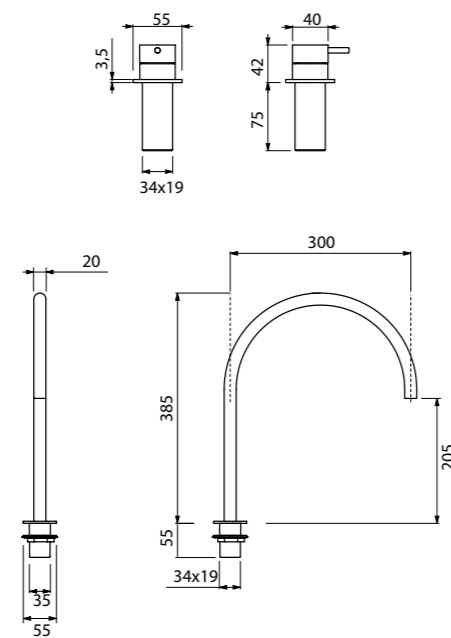

Cod. KCHB1S

Bocca bidet top girevole 160° con snodo

Deck-mounted swivel spout (160°) for bidet with swivel junction



Cod. KI12S

Miscelatore monocomando top

Single lever deck-mounted mixer

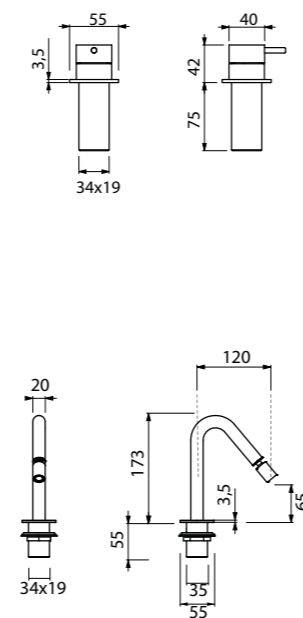

Cod. KI32S

Set per lavabo 2 fori composto da miscelatore top e bocca di erogazione girev. 160° a ponte senza saltarello e scarico

2-holes basin group composed by deck mounted mixer with bridge 160° swivel spout without pop-up waste and drain

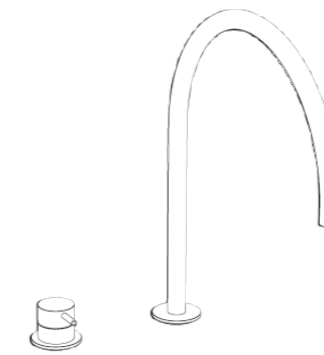
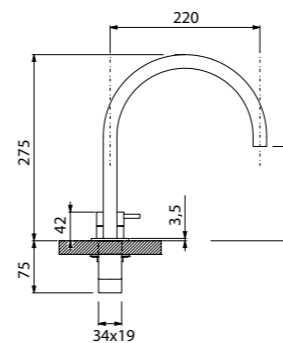
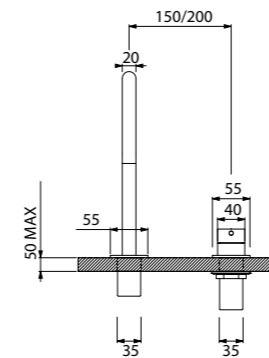

Cod. KI33S

Set per lavabo 2 fori composto da due comandi piantana con vitone ceramico e bocca girevole (160°) a ponte grande senza saltarello e scarico

2-holes basin group with two commands, large deck mounted mixer with ceramic valve and bridge 160° swivel spout without pop-up waste and drain

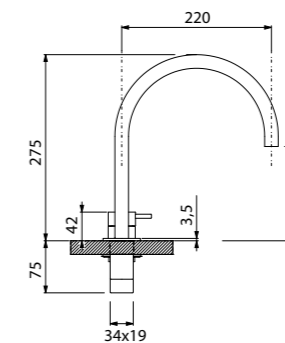
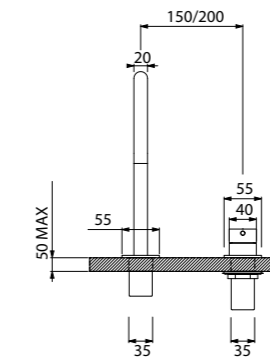

Cod. KI34S

Set per lavabo 2 fori composto da due comandi piantana con vitone ceramico e bocca girevole (160°) a ponte grande senza saltarello e scarico

2-holes basin group with two commands, large deck mounted mixer with ceramic valve and bridge 160° swivel spout without pop-up waste and drain

279

#KING Rubinetti da parete / Wall mounted taps

280



Cod. KI17S

Miscelatore lavabo due fori con canna curva L=100 senza salterello e scarico

2-hole built-in mixer with L=100 curved spout without pop up waste and drain

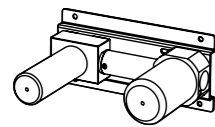

Cod. KINN18S

Parte incasso

Built-in Part

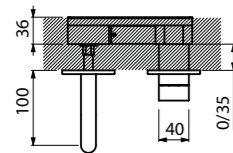
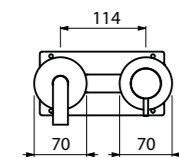
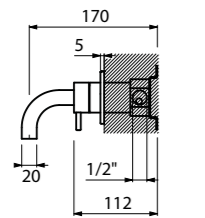

Cod. KI18S

Miscelatore lavabo due fori con canna curva L=190 senza salterello e scarico

2-hole built-in mixer with L=190 curved spout without pop up waste and drain

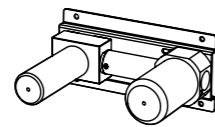

Cod. KINN18S

Parte incasso

Built-in Part

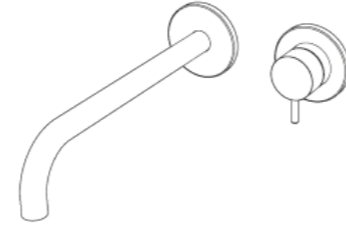
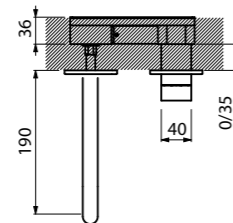
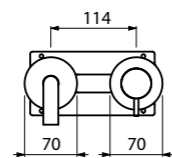
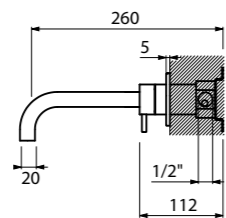

Cod. KI19S

Miscelatore lavabo due fori con canna curva L=250 senza salterello e scarico

2-hole built-in mixer with L=250 curved spout without pop up waste and drain

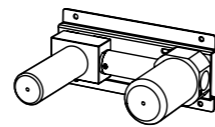

Cod. KINN18S

Parte incasso

Built-in Part

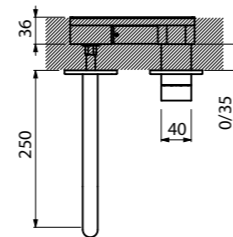
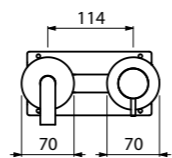
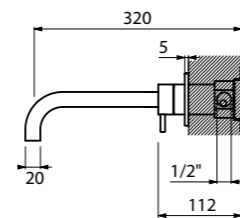

Cod. KCHC10S

Bocca lavabo a muro curva L=100

Wall-mounted washbasin spout L=100



Cod. KI8S

Miscelatore monocomando incasso a parete

Single lever wall-mounted mixer

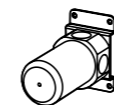

Cod. KINN8S

Miscelatore monocomando incasso a parete (parte incasso)

Single lever wall-mounted mixer (built-in part)

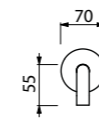
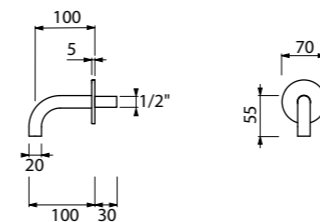

Cod. KCHC19S

Bocca lavabo a muro curva L=190

Wall-mounted washbasin spout L=190



Cod. KI8S

Miscelatore monocomando incasso a parete

Single lever wall-mounted mixer

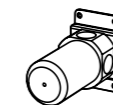

Cod. KINN8S

Miscelatore monocomando incasso a parete (parte incasso)

Single lever wall-mounted mixer (built-in part)

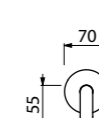
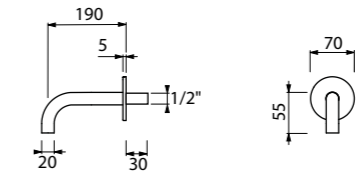

Cod. KCHC25S

Bocca lavabo a muro curva L=250

Wall-mounted washbasin spout L=250



Cod. KI8S

Miscelatore monocomando incasso a parete

Single lever wall-mounted mixer

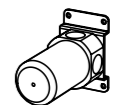

Cod. KINN8S

Miscelatore monocomando incasso a parete (parte incasso)

Single lever wall-mounted mixer (built-in part)

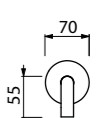
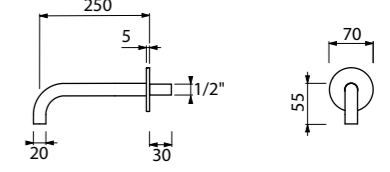

281

#KING Rubinetti da pavimento / Free-standing floor taps

282



Cod. KCHP50S

Bocca lavabo con alimentazione a pavimento con canna a ponte girevole

Free-standing floor washbasin spout with bridge-shaped swivel spout



Cod. KI8S

Miscelatore monocomando incasso a parete

Single lever wall-mounted mixer



Cod. KINN8S

Miscelatore monocomando incasso a parete (parte incasso)

Single lever wall-mounted mixer (built-in part)

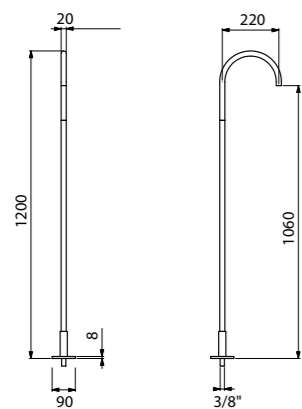

Cod. KCHP51S

Bocca lavabo con alimentazione a pavimento con canna a ponte grande

Free-standing floor basin spout with big bridge-shaped spout



Cod. KI8S

Miscelatore monocomando incasso a parete

Single lever wall-mounted mixer



Cod. KINN8S

Miscelatore monocomando incasso a parete (parte incasso)

Single lever wall-mounted mixer (built-in part)

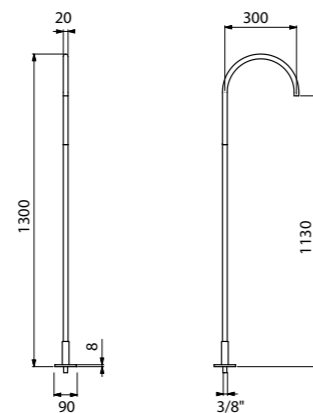

283

#KING Rubinetto da soffitto / Ceiling basin spout



Cod. KCHS1S*

Bocca lavabo con alimentazione a soffitto

Ceiling basin spout



Cod. KI8S

Miscelatore monocomando incasso a parete

Single lever wall-mounted mixer



Cod. KINN8S

Miscelatore monocomando incasso a parete (parte incasso)

Single lever wall-mounted mixer (built-in part)

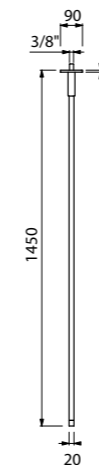

#KING Miscelatori / Mixers

284

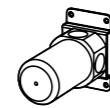

Cod. KTER51S*

Miscelatore termostatico coassiale incasso a muro con regolatore di portata

Built-in wall thermostatic mixer with waterflow capacity regulation

*Acquistabile con la parte incasso →
Non vendibile separatamente

*Can be purchased with the built-in part
Not to be sold separate

Cod. KINN1S

Miscelatore termostatico coassiale incasso a muro con regolatore di portata **(parte incasso)**

Built-in wall thermostatic mixer with waterflow capacity regulation **(built-in part)**

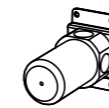
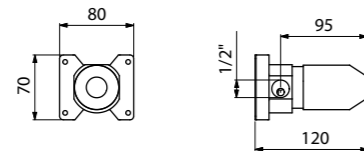
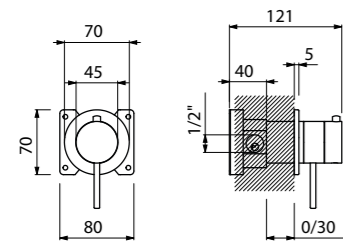

Cod. KI10S*

Comando deviatore incasso a due vie

Built-in 2 ways diverter

*Acquistabile con la parte incasso →
Non vendibile separatamente

*Can be purchased with the built-in part
Not to be sold separate

Cod. KINN10S

Comando deviatore incasso a due vie **(parte incasso)**

Built-in 2 ways diverter **(built-in part)**

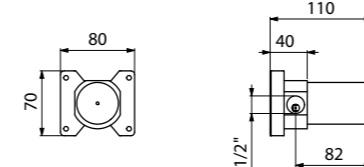
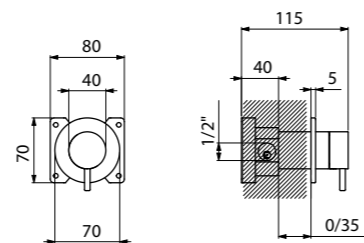

285

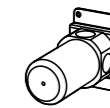

Cod. KI11S*

Comando deviatore incasso a tre vie

Built-in 3 ways diverter

*Acquistabile con la parte incasso →
Non vendibile separatamente

*Can be purchased with the built-in part
Not to be sold separate

Cod. KINN11S

Comando deviatore incasso a tre vie **(parte incasso)**

Built-in 3 ways diverter **(built-in part)**

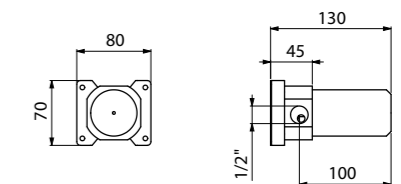
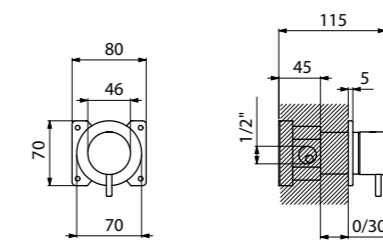

#KING Kit incasso doccia / Built-in shower mixers

286



Cod. KI9S

Miscelatore doccia incasso con deviatore 2 vie integrato

Built-in shower mixer with integrated 2-ways diverter

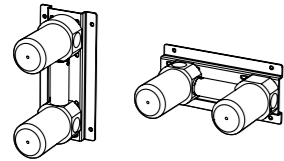

Cod. KINN9S

Miscelatore doccia incasso con deviatore 2 vie integrato **(parte incasso)**

Built-in shower mixer with integrated 2-ways diverter **(built-in part)**

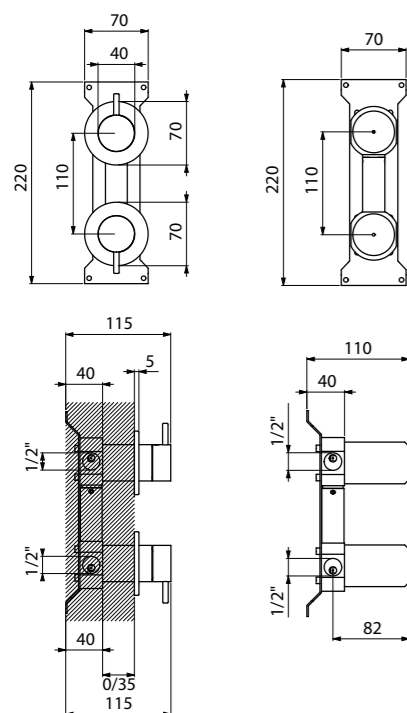

Cod. KI5S

Miscelatore doccia incasso con deviatore 3 vie integrato

Built-in shower mixer with integrated 3-ways diverter

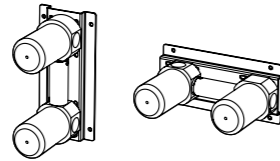

Cod. KINN5S

Miscelatore doccia incasso con deviatore 3 vie integrato **(parte incasso)**

Built-in shower mixer with integrated 3-ways diverter **(built-in part)**

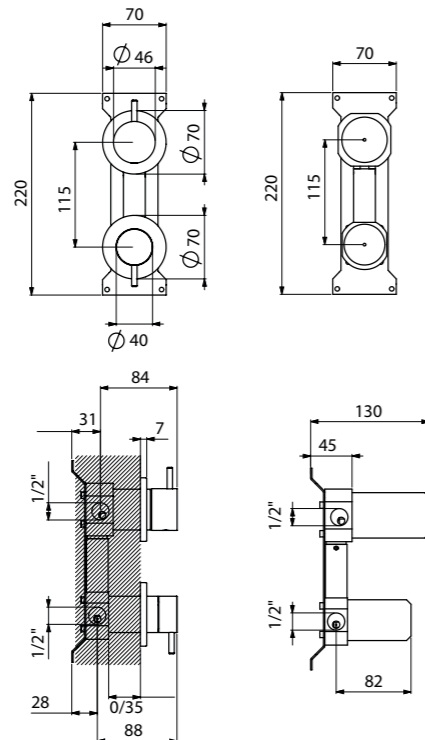

Cod. KTER52S

Miscelatore termostatico coassiale con regolatore di portata e deviatore 2 vie integrato

Coaxial thermostatic mixer with flow regulator and integrated 2 ways diverter

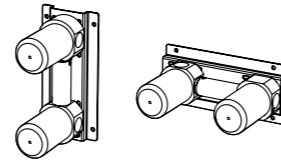

Cod. KINN2S

Miscelatore termostatico coassiale con regolatore di portata e deviatore 2 vie integrato **(parte incasso)**

Coaxial thermostatic mixer with flow regulator and integrated 2 ways diverter **(built-in part)**

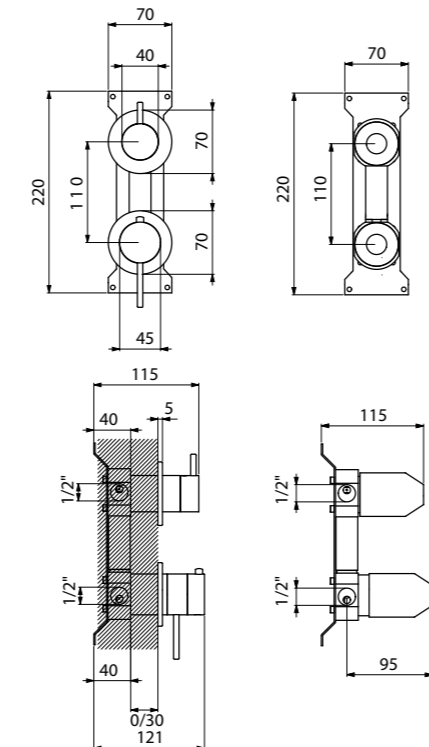

Cod. KTER53S

Miscelatore termostatico coassiale con regolatore di portata e deviatore 3 vie integrato

Coaxial thermostatic mixer with flow regulator and integrated 3 ways diverter

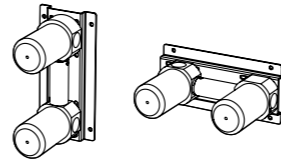

Cod. KINN3S

Miscelatore termostatico coassiale con regolatore di portata e deviatore 3 vie integrato **(parte incasso)**

Coaxial thermostatic mixer with flow regulator and integrated 3 ways diverter **(built-in part)**

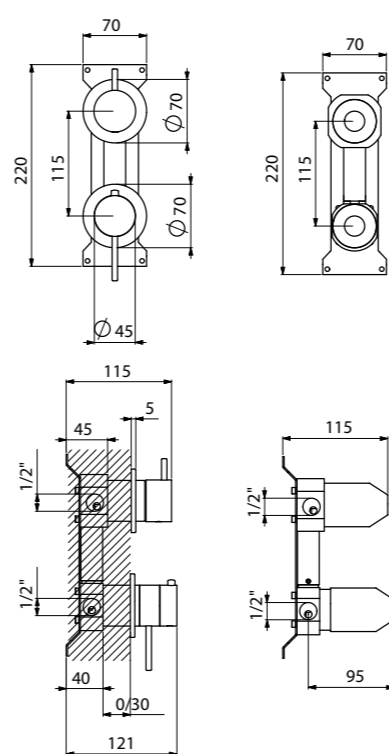

287

#KING Soffioni / Shower heads

288

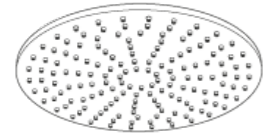

Cod. KSOF2

Soffione tondo ispezionabile Ø325 mm, spessore 10 mm

Inspectionable round shower head Ø325 mm, thickness 10 mm

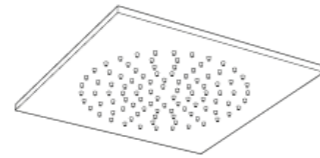
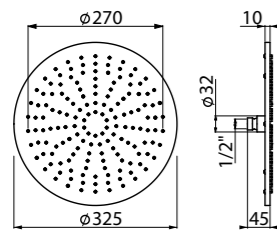

Cod. KSOF4

Soffione quadro ispezionabile 325x325 mm, spessore 10 mm

Inspectionable squared shower head 325x325 mm, thickness 10 mm

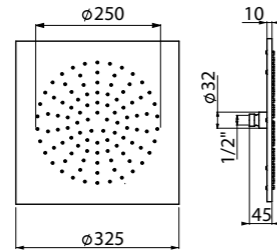

Cod. KBRA1

Braccio doccia inox a parete

Inox wall shower arm

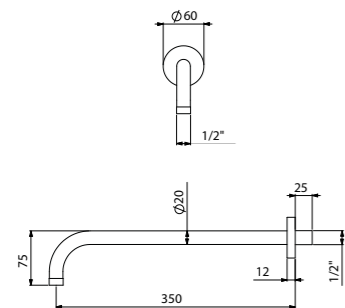

Cod. KBRA50

Braccio doccia inox a soffitto

Inox ceiling shower arm

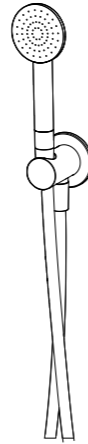
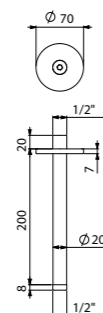

Cod. K20S1S

Kit presa acqua con supporto, doccino Ø70 e flessibile

Kit with water connection with older, Ø70 hand shower and flexible hose

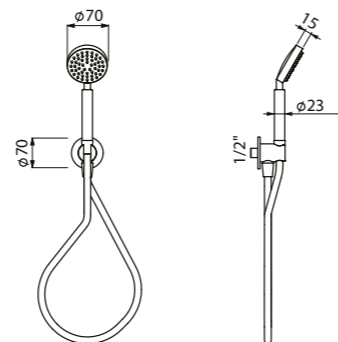

#KING Piantana Vasca / Free-standing Bath group

289

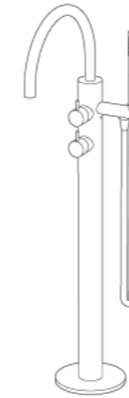

Cod. KIPV99S

Piantana vasca Ø 60 a ponte con doccetta

Free-standing bath group Ø 60 with bridge-shaped spout and hand shower



Cod. KINV2

Parte incasso

Built-in Part

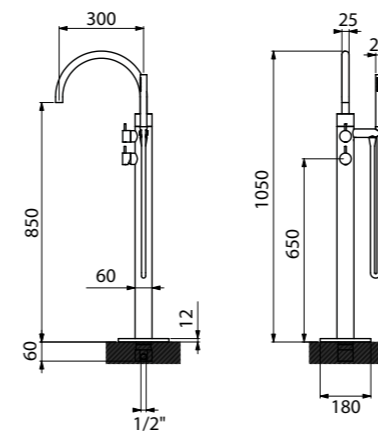

Cod. KIPV3S

Piantana vasca Ø 40 con doccetta

Free-standing bath group Ø 40 with and hand shower

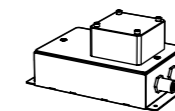

Cod. KINV3

Parte incasso

Built-in Part

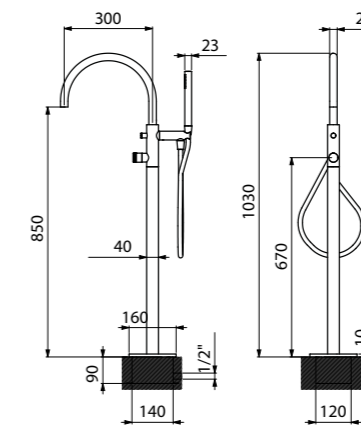

#KING Kit Miscelatore Vasca / Bath group

290

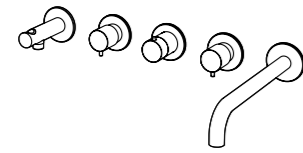

Cod. KIN52S*

Kit per miscelatore vasca incasso a muro orizzontale formato da miscelatore termostatico, collettore 2 vie, bocca di erogazione fissa, supporto, doccino cilindrico e flessibile nero 150 cm raccordo 3/4"

Horizontal built-in bath group made of thermostatic mixer, 2 ways manifold, spout, fixed holder, cilindric hand shower and black cm 150 flexible hose-3/4" connection

*Acquistabile con la parte incasso → Non vendibile separatamente

*Can be purchased with the built-in part Not to be sold separate

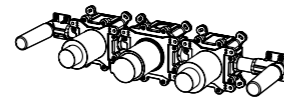
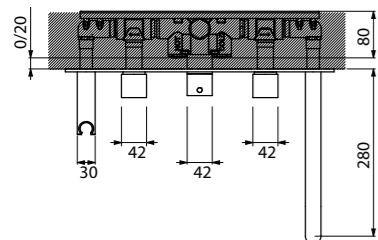
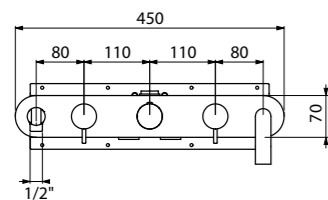
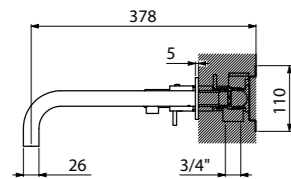

Cod. KINN52S

Kit per miscelatore vasca incasso a muro orizzontale formato da miscelatore termostatico, collettore 2 vie, bocca di erogazione fissa, supporto, doccino cilindrico e flessibile nero 150 cm raccordo 3/4" **(parte incasso)**

Horizontal built-in bath group made of thermostatic mixer, 2 ways manifold, spout, fixed holder, cilindric hand shower and black cm 150 flexible hose-3/4" connection **(built-in part)**

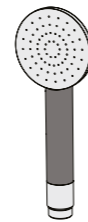
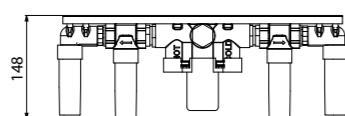
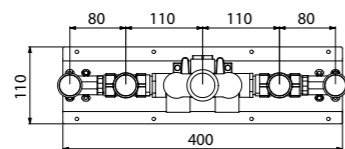

Cod. KDWN2

Doccino cilindrico

Hand shower

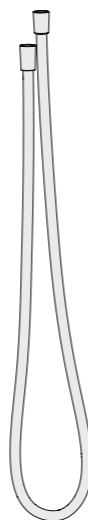

Cod. KIFLEX3S

Flessibile nero 150 cm raccordo 3/4"

Flexible hose-3/4" connection

291

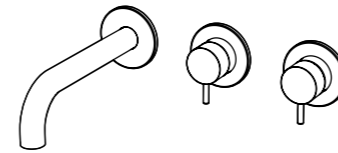

Cod. KV82S*

Set vasca orizzontale 2 vie

Parte estetica per miscelatore vasca incasso meccanico con deviatore 2 vie integrato e bocca di erogazione fissa L=190 mm, per installazione orizzontale

Horizontal bath set with 2-ways diverter

External part for manual bath mixer with integrated 2-ways diverter and L=190 mm fixed spout, horizontal installation

*Acquistabile con la parte incasso → Non vendibile separatamente

*Can be purchased with the built-in part Not to be sold separate

*Abbinabile a supporto_doccino_e flessibile

* Can be combined with flexible shower support

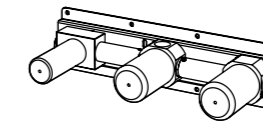

Cod. KINN16S

Set vasca orizzontale 2 vie

Parte estetica per miscelatore vasca incasso meccanico con deviatore 2 vie integrato e bocca di erogazione fissa L=190 mm, per installazione orizzontale **(parte incasso)**

Horizontal bath set with 2-ways diverter

External part for manual bath mixer with integrated 2-ways diverter and L=190 mm fixed spout, horizontal installation **(built-in part)**

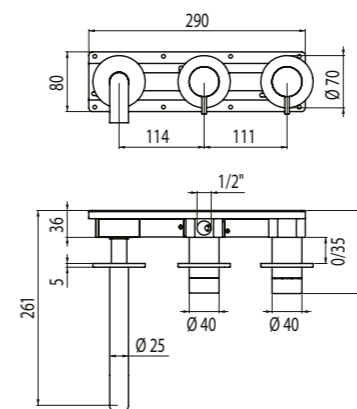

#KING Kit Miscelatore Vasca / Bath group

292



Cod. KV84S*

Set vasca orizzontale 2 vie TERMOSTATICO

Parte estetica per miscelatore vasca incasso termostatico con deviatore 2 vie integrato e bocca di erogazione fissa L=190 mm, per installazione orizzontale

Horizontal bath set with 2-ways diverter THERMOSTATIC

External part for thermostatic bath mixer with integrated 2-ways diverter and L=190 mm fixed spout, horizontal installation

*Acquistabile con la parte incasso →
Non vendibile separatamente

*Can be purchased with the built-in part
Not to be sold separate

*Abbinabile a supporto_doccino_e flessibile

* Can be combined with flexible shower support

Cod. KINN17S

Set vasca orizzontale 2 vie

Parte estetica per miscelatore vasca incasso termostatico con deviatore 2 vie integrato e bocca di erogazione fissa L=190 mm, per installazione orizzontale **(parte incasso)**

Horizontal bath set with 2-ways diverter

External part for thermostatic bath mixer with integrated 2-ways diverter and L=190 mm fixed spout, horizontal installation **(built-in part)**

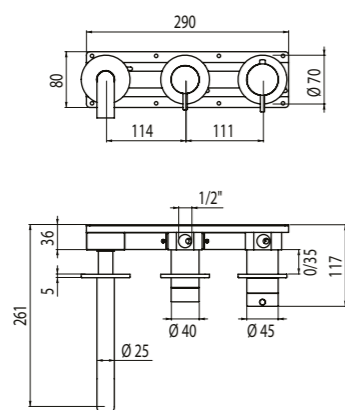

293

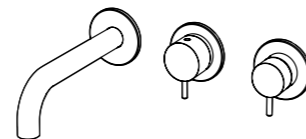

Cod. KV88S

Set vasca orizzontale 3 vie

Parte estetica per miscelatore vasca incasso meccanico con deviatore 3 vie integrato e bocca di erogazione fissa L=190 mm, per installazione orizzontale

Horizontal bath set with 3-ways diverter

External part for manual bath mixer with integrated 3-ways diverter and L=190 mm fixed spout, horizontal installation

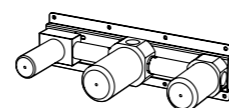

Cod. KINN19S

Parte incasso

Built-in Parta

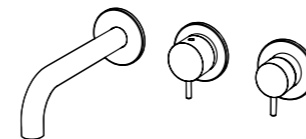

Cod. KV88S

Set vasca orizzontale 3 vie TERMOSTATICO

Parte estetica per miscelatore vasca incasso termostatico con deviatore 3 vie integrato e bocca di erogazione fissa L=190 mm, per installazione orizzontale

Horizontal bath set with 3-ways diverter THERMOSTATIC

External part for thermostatic bath mixer with integrated 3-ways diverter and L=190 mm fixed spout, horizontal installation

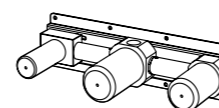

Cod. KINN20S

Parte incasso

Built-in Part

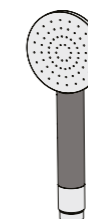

Cod. KDWN2

Doccino cilindrico

Hand shower



Cod. KDWN2

Supporto doccino

Fixed holder

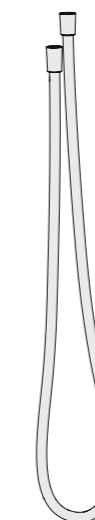

Cod. KIFLEX3S

Flessibile nero 150 cm
raccordo 3/4"

Flexible hose-3/4" connection

#KING Bocca Vasca / Bath spout

294

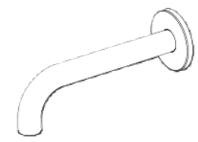

Cod. KCHV19S*

Bocca vasca a muro L=190 mm
Wall-mounted bath spout L=190 mm

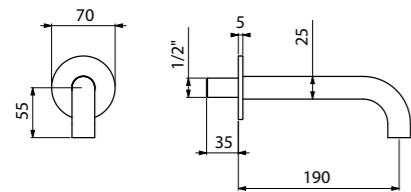

* Da utilizzare con:
Il miscelatore monocomando incasso a parete cod. **KI8S** e con la Parte Incasso cod. **KINC8S**
O con:
Il miscelatore termostatico coassiale incasso a muro con regolatore di portata cod. **KTER51S** e con la Parte Incasso cod. **KINC1S**

* To be used with:
The single lever wall mounted mixer cod. **KI8S** and Built-in Part cod. **KINC8S**
Or with:
Built-in wall thermostatic mixer with waterflow capacity regulation cod. **KTER51S** and Built-in Part cod. **KINC1S**

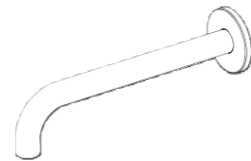

Cod. KCHV25S*

Bocca vasca a muro L=250 mm
Wall-mounted bath spout L= 250 mm

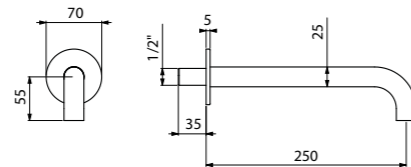

* Da utilizzare con:
Il miscelatore monocomando incasso a parete cod. **KI8S** e con la Parte Incasso cod. **KINC8S**
O con:
Il miscelatore termostatico coassiale incasso a muro con regolatore di portata cod. **KTER51S** e con la Parte Incasso cod. **KINC1S**

* To be used with:
The single lever wall mounted mixer cod. **KI8S** and Built-in Part cod. **KINC8S**
Or with:
Built-in wall thermostatic mixer with waterflow capacity regulation cod. **KTER51S** and Built-in Part cod. **KINC1S**



Cod. KCHV1S*

Bocca vasca con alimentazione a pavimento
Floor-mounted bath spout

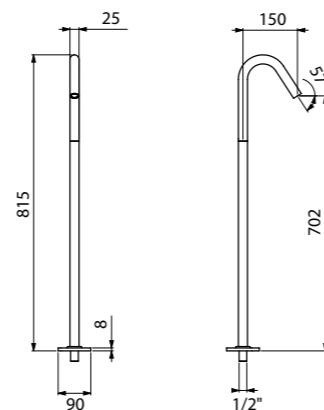

* Da utilizzare con:
Il miscelatore monocomando incasso a parete cod. **KI8S** e con la Parte Incasso cod. **KINC8S**
O con:
Il miscelatore termostatico coassiale incasso a muro con regolatore di portata cod. **KTER51S** e con la Parte Incasso cod. **KINC1S**

* To be used with:
The single lever wall mounted mixer cod. **KI8S** and Built-in Part cod. **KINC8S**
Or with:
Built-in wall thermostatic mixer with waterflow capacity regulation cod. **KTER51S** and Built-in Part cod. **KINC1S**

#KING Rubinetti Arresto / Stop Valve

295



Cod. KI49S*

Rubinetto di arresto incasso a muro con raccordi da 1/2"

Built-in stop valve with 1/2" connection

Cod. KINC49S

Rubinetto di arresto incasso a muro con raccordi da 1/2" (**parte incasso**)

Built-in stop valve with 1/2" connection (**built-in part**)

*Acquistabile con la parte incasso → Non vendibile separatamente

*Can be purchased with the built-in part Not to be sold separate

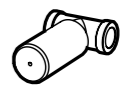
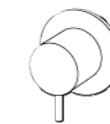

Cod. KI50S*

Rubinetto di arresto incasso a muro con raccordi da 3/4"

Built-in stop valve with 3/4" connection

Cod. KINC50S

Rubinetto di arresto incasso a muro con raccordi da 3/4" (**parte incasso**)

Built-in stop valve with 3/4" connection (**built-in part**)

*Acquistabile con la parte incasso → Non vendibile separatamente

*Can be purchased with the built-in part Not to be sold separate

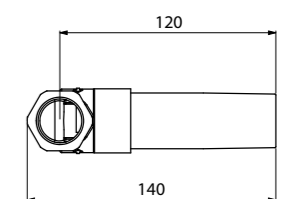
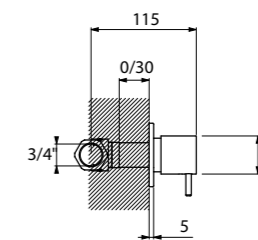
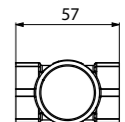
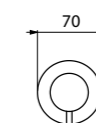
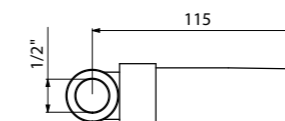
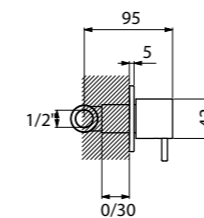
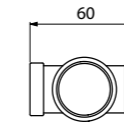
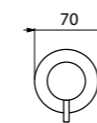

#KING Accessori / Accessories

296

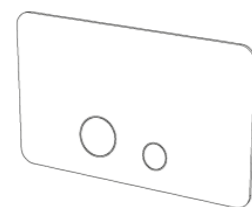

Cod. KTEKAS

Placca per cassetta wc doppio flusso compatibile con Geberit mod. Sigma 8 (109.790.00.1)

Flush plate for dual flush system compatible with Geberit mod. Sigma 8 (109.790.00.1)

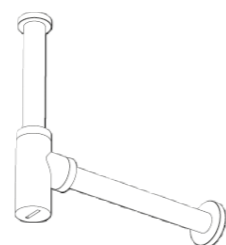
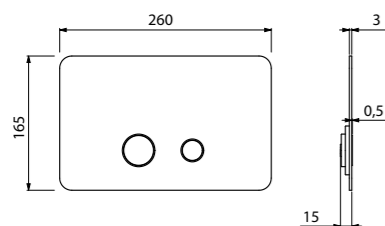

Cod. KSIF1S

Sifone 1" 1/4 tondo

Round Siphon 1" 1/4

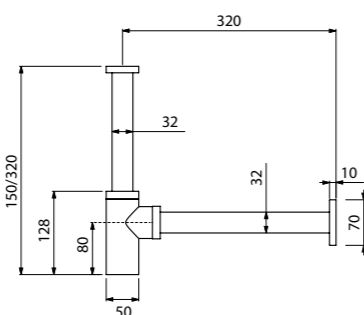

Cod. KSCA1

Piletta click-clack h. 25-60 con troppo-pieno. Spessore minimo del lavabo 2 cm

Click-clack drain with overflow h.25-60. Basin minimum thickness 2 cm

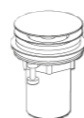
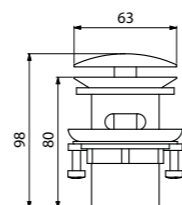

Cod. KSCA50

Piletta click-clack senza troppo-pieno

Click-clack drain without overflow

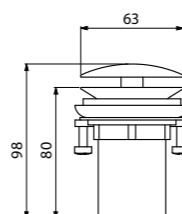

297

#SPECCHI



Cod. SP1

Specchio retroilluminato su 4 lati, accensione con pulsante touch 90x55 cm (reversibile)

Backlit Led mirror with touch ON/OFF sensor switch 90x55 cm (reversible)

• cm 90xh 55



Cod. SP2

Specchio retroilluminato su 4 lati, accensione con pulsante touch 120x55 cm (reversibile)

Backlit Led mirror with touch ON/OFF sensor switch 120x55 cm (reversible)

• cm 120xh 55



PULSANTE TOUCH
TOUCH ON/OFF SENSOR SWITCH

#SOLIDO Mobile da bagno / Bathroom cabinets

298

MOBILE SOLIDO 70 CM + TOP CON LAVABO INTEGRATO

Cod. MSS.7

Mobile SOLIDO 70 con 1 cassettone, vasca centrale

Cabinet SOLIDO 70 with 1 drawer, central basin

- cm 70x46 x h 41,2

Cod. PLS

Piletta click-clack universale con adattatore per scarico libero in ottone cromato e tappo in Solid Surface.

Universal click-clack drain with adapter for free drain in chromed brass with Solid Surface cap.

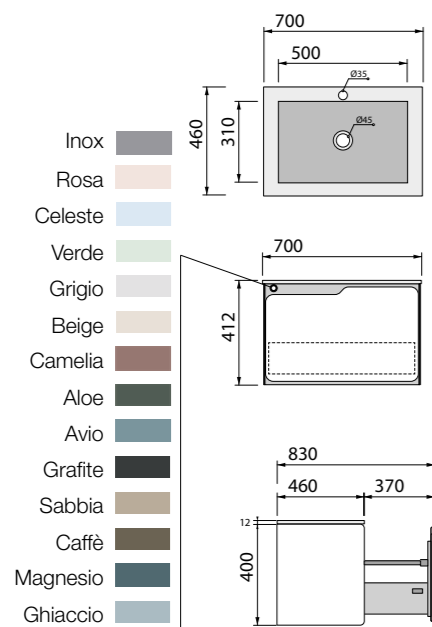

 SU MISURA **da 71 a 89 cm**
Custom-made **71 to 89 cm**

Cod. MSS.7X

Mobile SOLIDO **da 71 a 89 cm** su misura con 1 cassettone, vasca centrale

Cabinet SOLIDO custom-made from 71 to 89 cm with 1 drawer, central basin

- cm 71/89x46 x h 41,2

299

MOBILE SOLIDO 90 CM + TOP CON LAVABO INTEGRATO

Cod. MSS.9

Mobile SOLIDO 90 con 1 cassettone, vasca centrale

Cabinet SOLIDO 90 with 1 drawer, central basin

- cm 90x46 x h 41,2

Cod. PLS

Piletta click-clack universale con adattatore per scarico libero in ottone cromato e tappo in Solid Surface.

Universal click-clack drain with adapter for free drain in chromed brass with Solid Surface cap.

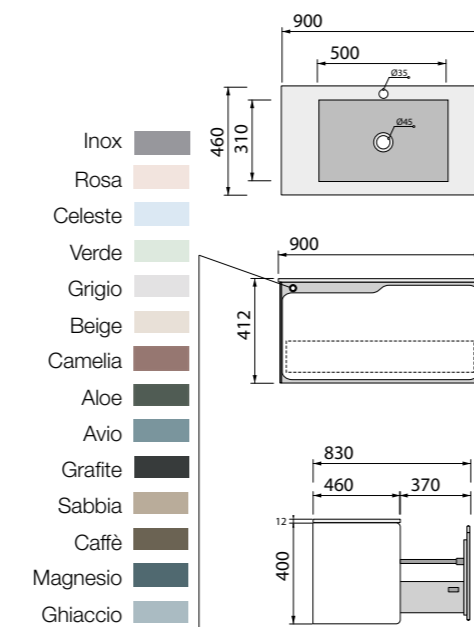

 SU MISURA **da 91 a 119 cm**
Custom-made **91 to 119 cm**

Cod. MSS.9X

Mobile SOLIDO **da 91 a 119 cm** su misura con 1 cassettone, vasca centrale

Cabinet SOLIDO custom-made from 91 to 119 cm with 1 drawer, central basin

- cm 91/119x46 x h 41,2

Cod. MSS.12.DX

Mobile SOLIDO 120 con 2 cassettoni, vasca destra

Cabinet SOLIDO 120 with 2 drawers, right basin

- cm 120x46 x h 41,2

Cod. PLS

Piletta click-clack universale con adattatore per scarico libero in ottone cromato e tappo in Solid Surface.

Universal click-clack drain with adapter for free drain in chromed brass with Solid Surface cap.

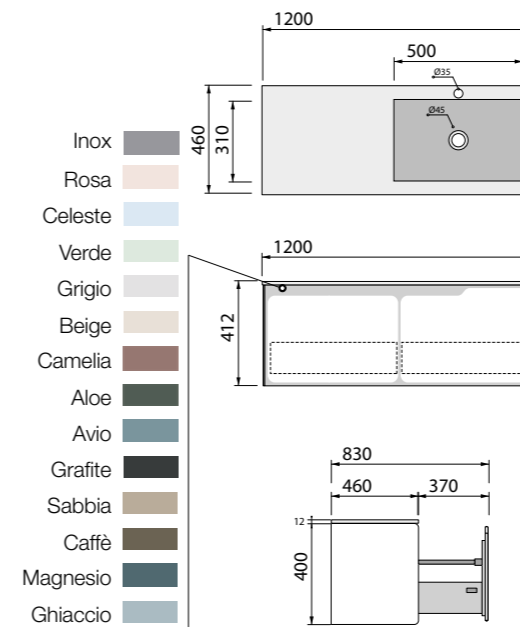

 SU MISURA **da 121 a 139 cm**
Custom-made **121 to 139 cm**

Cod. MSS.12X.DX

Mobile SOLIDO **da 121 a 139 cm** con 2 cassettoni, vasca destra

Cabinet SOLIDO from 121 to 139 cm with 2 drawers, right basin

- cm 121/139x46 x h 41,2

MOBILE SOLIDO 120 CM + TOP CON LAVABO INTEGRATO

Cod. MSS.12.SX

Mobile SOLIDO 120 con 2 cassettoni, vasca sinistra

Cabinet SOLIDO 120 with 2 drawers, left basin

- cm 120x46 x h 41,2

Cod. PLS

Piletta click-clack universale con adattatore per scarico libero in ottone cromato e tappo in Solid Surface.

Universal click-clack drain with adapter for free drain in chromed brass with Solid Surface cap.

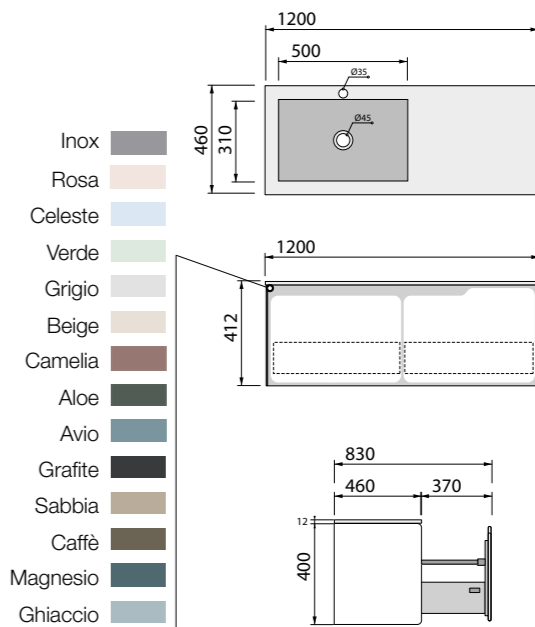

 SU MISURA **da 121 a 139 cm**
Custom-made **121 to 139 cm**

Cod. MSS.12X.SX

Mobile SOLIDO **da 121 a 139 cm** con 2 cassettoni, vasca sinistra

Cabinet SOLIDO from 121 to 139 cm with 2 drawers, left basin

- cm 121/139x46 x h 41,2

#SOLIDO Mobile da bagno / Bathroom cabinets

300

MOBILE SOLIDO 140 CM + TOP CON LAVABO INTEGRATO

Cod. MSS.14.DX

Mobile SOLIDO 140 con 2 cassettoni, vasca destra

Cabinet SOLIDO 140 with 2 drawers, right basin

- cm 140x46 x h 41,2

Cod. PLS

Piletta click-clack universale con adattatore per scarico libero in ottone cromato e tappo in Solid Surface.

Universal click-clack drain with adapter for free drain in chromed brass with Solid Surface cap.

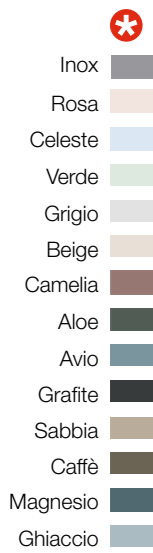
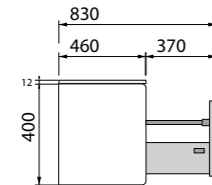
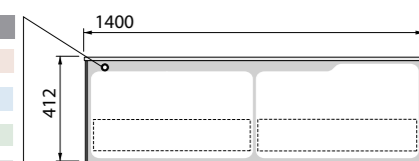
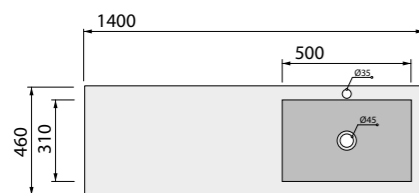

Cod. MSS.14.SX

Mobile SOLIDO 140 con 2 cassettoni, vasca sinistra

Cabinet SOLIDO 140 with 2 drawers, left basin

- cm 140x46 x h 41,2

Cod. PLS

Piletta click-clack universale con adattatore per scarico libero in ottone cromato e tappo in Solid Surface.

Universal click-clack drain with adapter for free drain in chromed brass with Solid Surface cap.

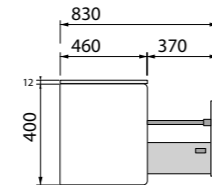
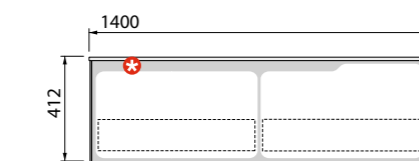
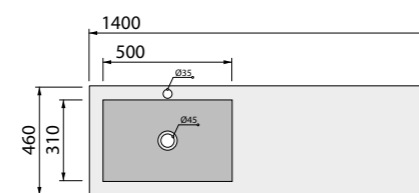

SU MISURA da 141 a 159 cm
Custom-made 141 to 159 cm

Cod. MSS.14X.DX

Mobile SOLIDO da 141 a 159 cm con 2 cassettoni, vasca destra

Cabinet SOLIDO from 141 to 159 cm with 2 drawers, right basin

- cm 141/159x46 x h 41,2

Cod. MSS.14X.SX

Mobile SOLIDO da 141 a 159 cm con 2 cassettoni, vasca sinistra

Cabinet SOLIDO from 141 to 159 cm with 2 drawers, left basin

- cm 141/159x46 x h 41,2

Cod. MSS.14.2

Mobile SOLIDO 140 con 2 cassettoni, doppia vasca

Cabinet SOLIDO 140 with 2 drawers, double basin

- cm 140x46 x h 41,2

Cod. PLS

Piletta click-clack universale con adattatore per scarico libero in ottone cromato e tappo in Solid Surface.

Universal click-clack drain with adapter for free drain in chromed brass with Solid Surface cap.

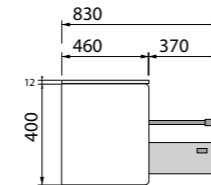
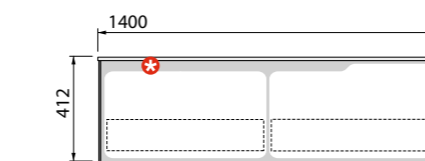
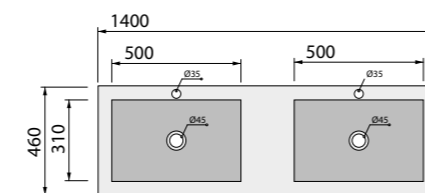

Cod. MSS.16.DX

Mobile SOLIDO 160 con 2 cassettoni, vasca destra

Cabinet SOLIDO 160 with 2 drawers, right basin

- cm 160x46 x h 41,2

Cod. PLS

Piletta click-clack universale con adattatore per scarico libero in ottone cromato e tappo in Solid Surface.

Universal click-clack drain with adapter for free drain in chromed brass with Solid Surface cap.

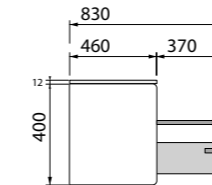
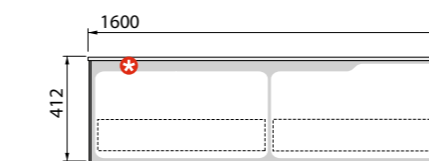
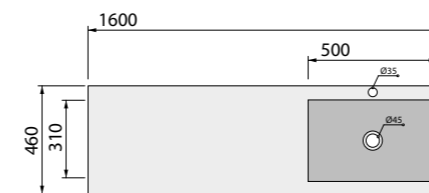

MOBILE SOLIDO 160 CM + TOP CON LAVABO INTEGRATO

301

Cod. MSS.16.SX

Mobile SOLIDO 160 con 2 cassettoni, vasca sinistra

Cabinet SOLIDO 160 with 2 drawers, left basin

- cm 160x46 x h 41,2

Cod. PLS

Piletta click-clack universale con adattatore per scarico libero in ottone cromato e tappo in Solid Surface.

Universal click-clack drain with adapter for free drain in chromed brass with Solid Surface cap.

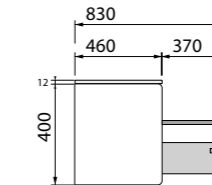
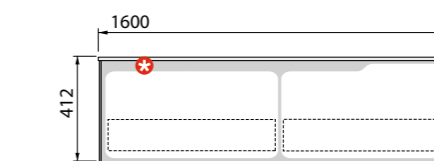
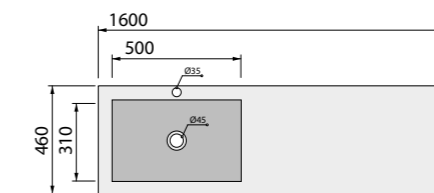

SU MISURA da 161 a 200 cm
Custom-made 161 to 200 cm

Cod. MSS.16X.DX

Mobile SOLIDO da 161 a 200 cm con 2 cassettoni, vasca destra

Cabinet SOLIDO from 161 to 200 cm with 2 drawers, right basin

- cm 161/200x46 x h 41,2

Cod. MSS.16X.SX

Mobile SOLIDO da 161 a 200 cm con 2 cassettoni, vasca sinistra

Cabinet SOLIDO from 161 to 200 cm with 2 drawers, left basin

- cm 161/200x46 x h 41,2

Cod. MSS.16.2

Mobile SOLIDO 160 con 2 cassettoni, doppia vasca

Cabinet SOLIDO 160 with 2 drawers, double basin

- cm 160x46 x h 41,2

Cod. PLS

Piletta click-clack universale con adattatore per scarico libero in ottone cromato e tappo in Solid Surface.

Universal click-clack drain with adapter for free drain in chromed brass with Solid Surface cap.

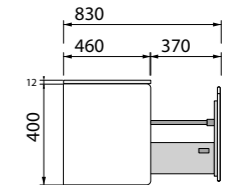
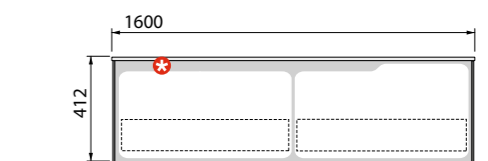
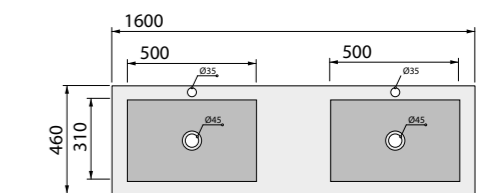

Cod. MSS.16X.2

Mobile SOLIDO da 161 a 200 cm con 2 cassettoni, doppia vasca

Cabinet SOLIDO from 161 to 200 cm with 2 drawers, double basin

- cm 161/200x46 x h 41,2

#SOLIDO Mobile da bagno / Bathroom cabinets

302

MOBILE SOLIDO 70 CM + TOP IN SOLID SURFACE (SENZA LAVABO)

Cod. MS.7

Mobile SOLIDO 70 con 1 cassettone, top

Cabinet SOLIDO 70 with 1 drawer, top

- cm 70x46 x h 41,2

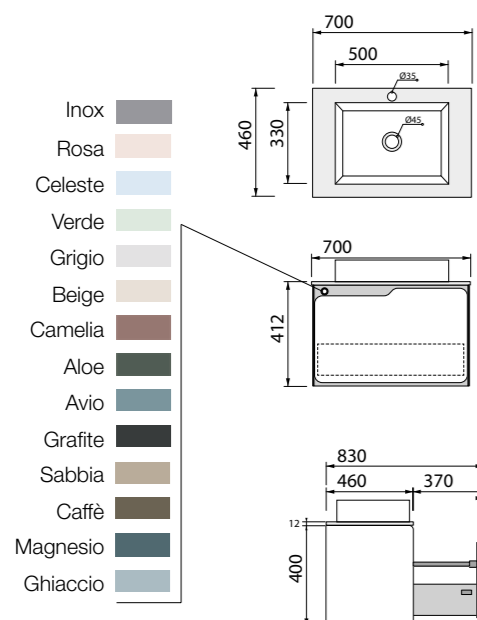

 SU MISURA **da 71 a 89 cm**
Custom-made **71 to 89 cm**

Cod. MS.7X

Mobile SOLIDO **da 71 a 89 cm** su misura con 1 cassettone, top

Cabinet SOLIDO custom-made from 71 to 89 cm with 1 drawer, top

- cm 71/89x46 x h 41,2

303

MOBILE SOLIDO 90 CM + TOP IN SOLID SURFACE (SENZA LAVABO)

Cod. MS.9

Mobile SOLIDO 90 con 1 cassettone, top

Cabinet SOLIDO 90 with 1 drawer, top

- cm 90x46 x h 41,2

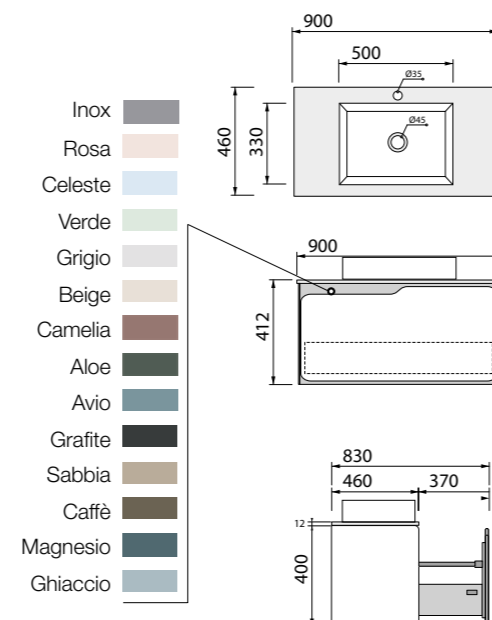

 SU MISURA **da 91 a 119 cm**
Custom-made **91 to 119 cm**

Cod. MS.9X

Mobile SOLIDO **da 91 a 119 cm** su misura con 1 cassettone, top

Cabinet SOLIDO custom-made from 91 to 119 cm with 1 drawer, top

- cm 91/119x46 x h 41,2

MOBILE SOLIDO 120 CM + TOP IN SOLID SURFACE (SENZA LAVABO)

Cod. MS.12.DX

Mobile SOLIDO 120 con 2 cassettoni, top

Cabinet SOLIDO 120 with 2 drawers, top

- cm 120x46 x h 41,2

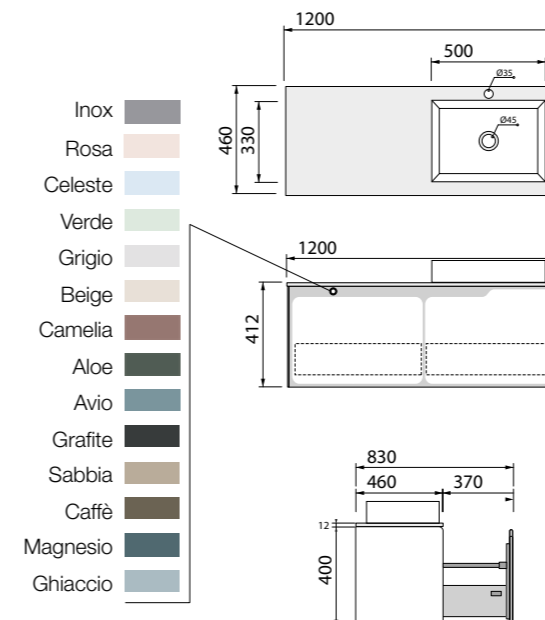

 SU MISURA **da 121 a 139 cm**
Custom-made **121 to 139 cm**

Cod. MS.12X.DX

Mobile SOLIDO **da 121 a 139 cm** con 2 cassettoni, top

Cabinet SOLIDO from 121 to 139 cm with 2 drawers, top

- cm 121/139x46 x h 41,2

Cod. MS.12.SX

Mobile SOLIDO 120 con 2 cassettoni, top

Cabinet SOLIDO 120 with 2 drawers, top

- cm 120x46 x h 41,2

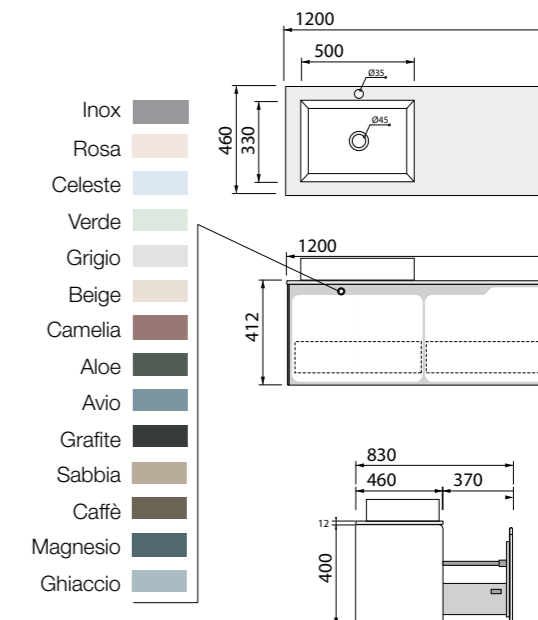

 SU MISURA **da 121 a 139 cm**
Custom-made **121 to 139 cm**

Cod. MS.12X.SX

Mobile SOLIDO **da 121 a 139 cm** con 2 cassettoni, top

Cabinet SOLIDO from 121 to 139 cm with 2 drawers, top

- cm 121/139x46 x h 41,2

#SOLIDO Mobile da bagno / Bathroom cabinets

MOBILE SOLIDO 140 CM + TOP IN SOLID SURFACE (SENZA LAVABO)

Cod. MS.14.DX

Mobile SOLIDO 140 con 2 cassettoni, top
Cabinet SOLIDO 140 with 2 drawers, top
• cm 140x46 x h 41,2

Cod. MS.14.SX

Mobile SOLIDO 140 con 2 cassettoni, top
Cabinet SOLIDO 140 with 2 drawers, top
• cm 140x46 x h 41,2

Cod. MS.14.2

Mobile SOLIDO 140 con 2 cassettoni, top
Cabinet SOLIDO 140 with 2 drawers, top
• cm 140x46 x h 41,2

Cod. MS.16.DX

Mobile SOLIDO 160 con 2 cassettoni, top
Cabinet SOLIDO 160 with 2 drawers, top
• cm 160x46 x h 41,2

MOBILE SOLIDO 160 CM + TOP IN SOLID SURFACE (SENZA LAVABO)

Cod. MS.16.SX

Mobile SOLIDO 160 con 2 cassettoni, top
Cabinet SOLIDO 160 with 2 drawers, top
• cm 160x46 x h 41,2

Cod. MS.16.2

Mobile SOLIDO 160 con 2 cassettoni, top
Cabinet SOLIDO 160 with 2 drawers, top
• cm 160x46 x h 41,2

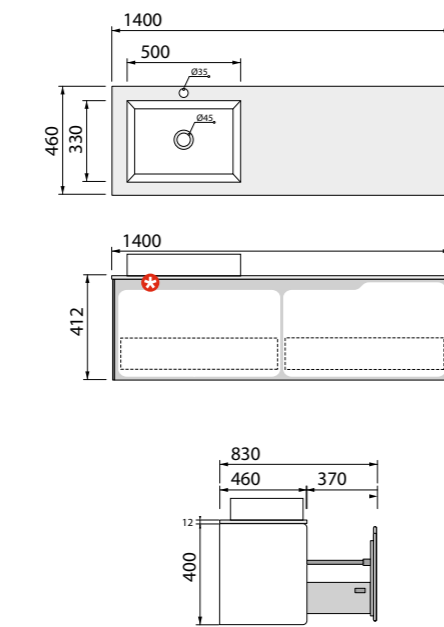
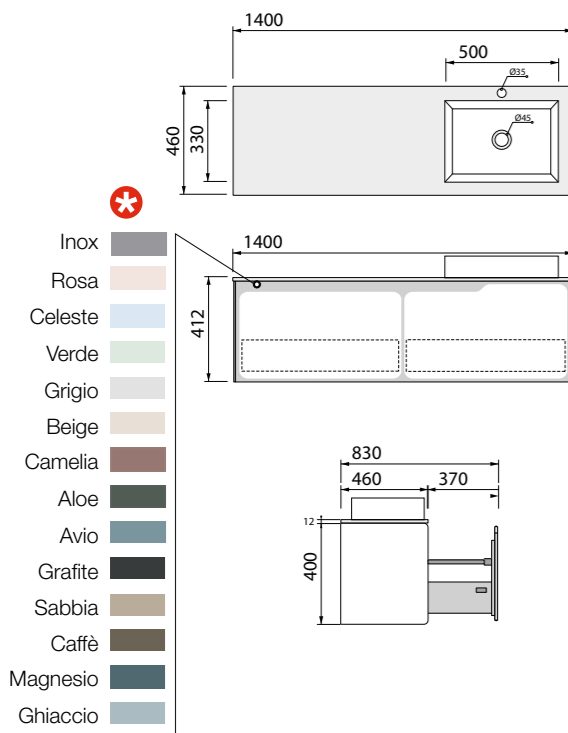

 SU MISURA **da 141 a 159 cm**
Custom-made **141 to 159 cm**

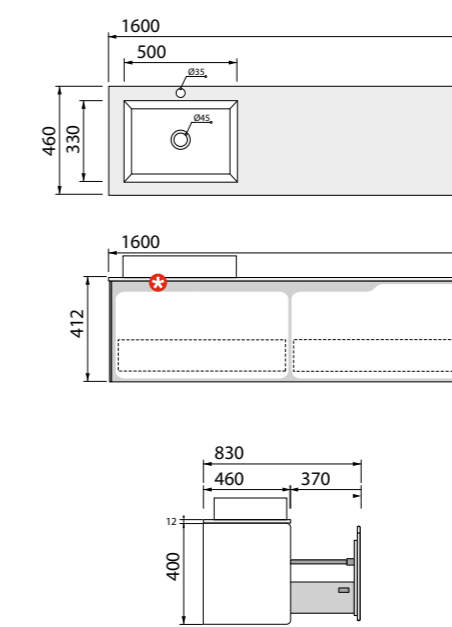
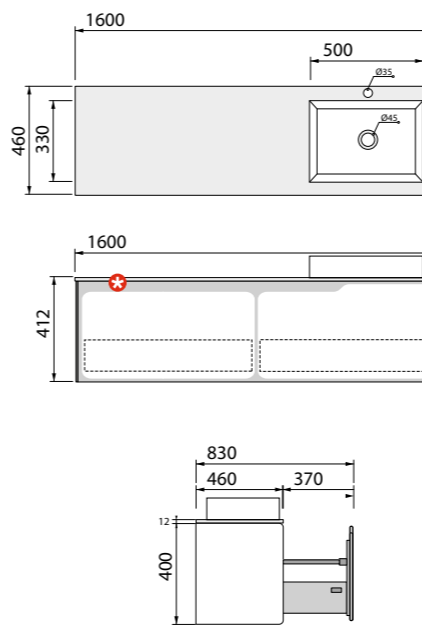
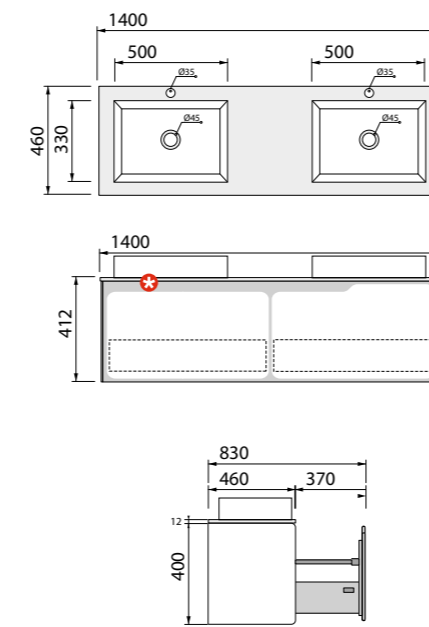

 SU MISURA **da 161 a 200 cm**
Custom-made **161 to 200 cm**

Cod. MS.14X.DX

Mobile SOLIDO **da 141 a 159 cm**
con 2 cassettoni, top
Cabinet SOLIDO from 141 to 159 cm with
2 drawers, top
• cm 141/159x46 x h 41,2

Cod. MS.14X.SX

Mobile SOLIDO **da 141 a 159 cm**
con 2 cassettoni, top
Cabinet SOLIDO from 141 to 159 cm with
2 drawers, top
• cm 141/159x46 x h 41,2

Cod. MS.14X.2

Mobile SOLIDO **da 141 a 159 cm**
con 2 cassettoni, top
Cabinet SOLIDO from 141 to 159 cm with
2 drawers, top
• cm 141/159x46 x h 41,2

Cod. MS.16X.DX

Mobile SOLIDO **da 161 a 200 cm**
con 2 cassettoni, top
Cabinet SOLIDO from 161 to 200 cm with
2 drawers, top
• cm 161/200x46 x h 41,2

Cod. MS.16X.SX

Mobile SOLIDO **da 161 a 200 cm**
con 2 cassettoni, top
Cabinet SOLIDO from 161 to 200 cm with
2 drawers, top
• cm 161/200x46 x h 41,2

Cod. MS.16X.2

Mobile SOLIDO **da 161 a 200 cm**
con 2 cassettoni, top
Cabinet SOLIDO from 161 to 200 cm with
2 drawers, top
• cm 161/200x46 x h 41,2

#CASSETTO REVOLUTION

306



Cod. CAR

Cassetto con fissaggio a parete L=30 cm

Drawer with wall fixing kit L=30 cm

- cm 30xh30xp47

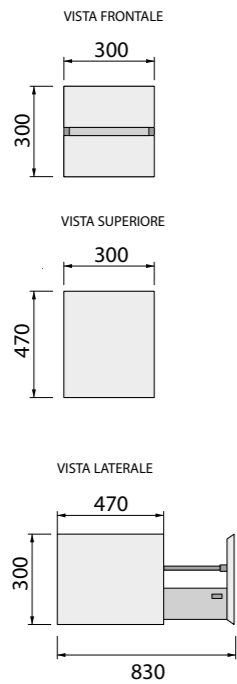

	Rosa		Panna
	Celeste		Bianco Lucido
	Verde		Grafite
	Grigio		Sabbia
	Beige		Caffè
	Camelia		Magnesio
	Aloe		Ghiaccio
	Avio		



Cod. CAR.36

Cassetto con fissaggio a parete L=60 cm

Drawer with wall fixing kit L=60 cm

- cm 60xh30xp47

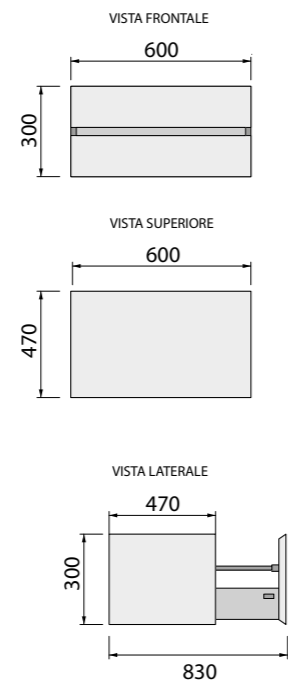

	Rosa		Panna
	Celeste		Bianco Lucido
	Verde		Grafite
	Grigio		Sabbia
	Beige		Caffè
	Camelia		Magnesio
	Aloe		Ghiaccio
	Avio		



Cod. CAR.39

Cassetto con fissaggio a parete L=90 cm

Drawer with wall fixing kit L=90 cm

- cm 90xh30xp47

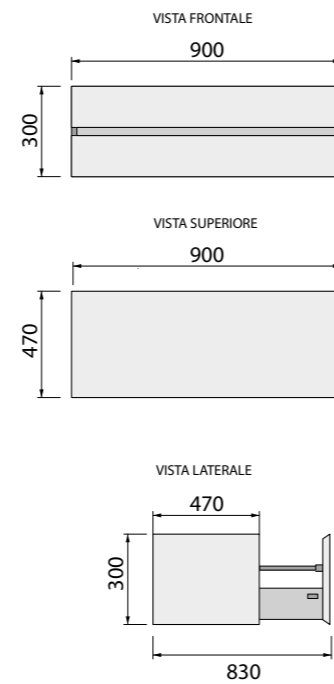

	Rosa		Panna
	Celeste		Bianco Lucido
	Verde		Grafite
	Grigio		Sabbia
	Beige		Caffè
	Camelia		Magnesio
	Aloe		Ghiaccio
	Avio		



Cod. CAR.312

Cassetto con fissaggio a parete L=120 cm

Drawer with wall fixing kit L=120 cm

- cm 120xh30xp47

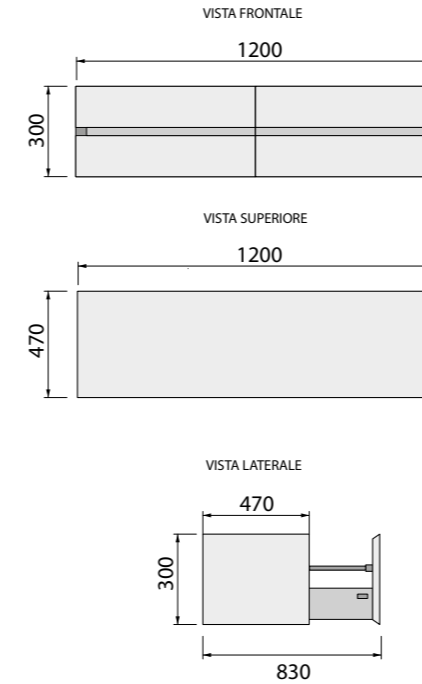

	Rosa		Panna
	Celeste		Bianco Lucido
	Verde		Grafite
	Grigio		Sabbia
	Beige		Caffè
	Camelia		Magnesio
	Aloe		Ghiaccio
	Avio		

307

**ESEMPI DI INSTALLAZIONE
EXAMPLE OF INSTALLATION**

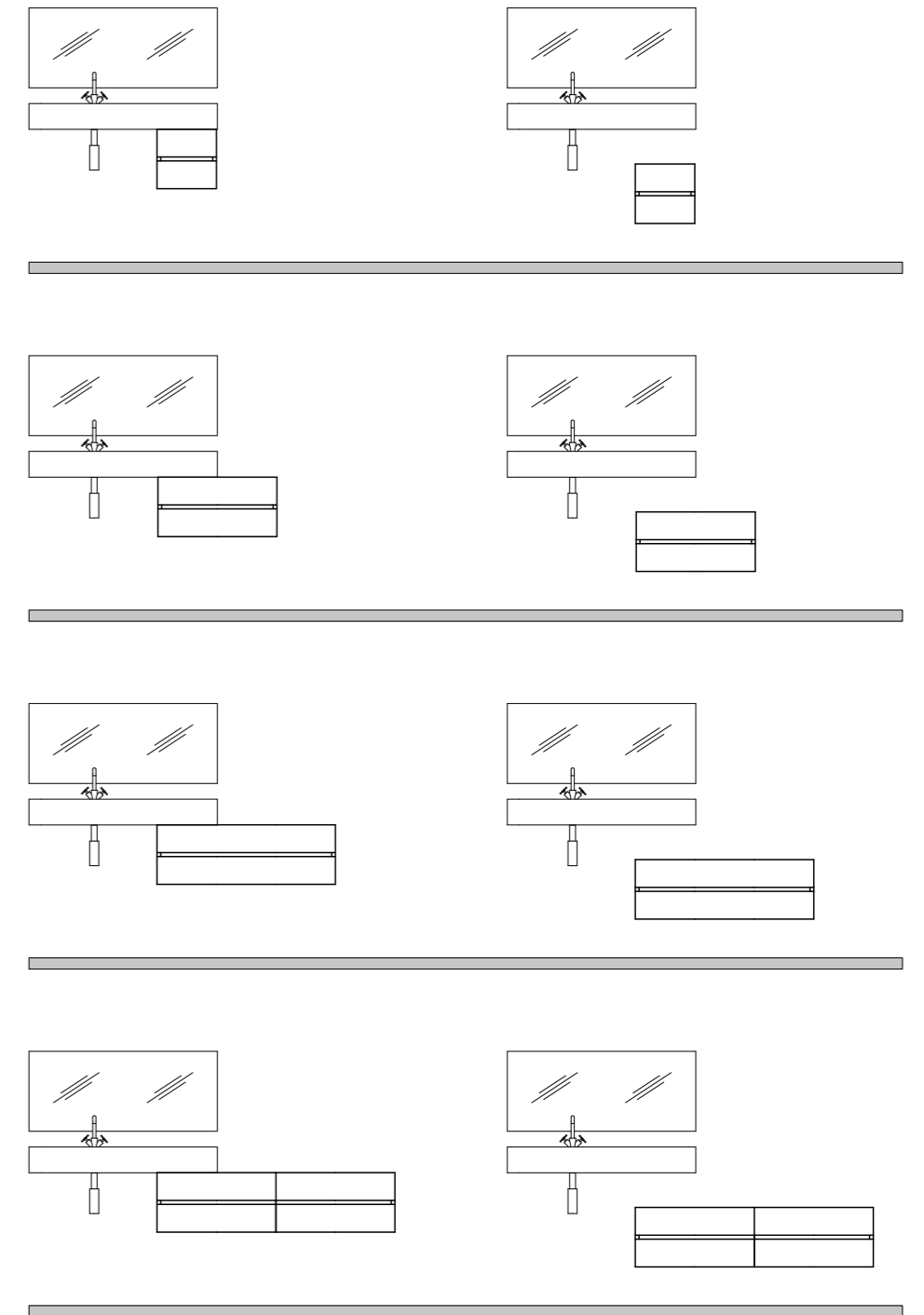

#RICAMBI

308

**Cod. FIXT**Coppia fissaggi per sanitari a terra
Back to wall wc/bidet fixing kit**Cod. FIXSL**Kit fissaggio nascosto per sanitari sospesi
Hidden fixing with side activation**Cod. FIXL**Kit fissaggio lavabo
Washbasin fixing kit**Cod. KCSLIM**Kit cerniere sedile SLIM
SLIM seat cover fixing kit**Cod. KFSLIM**Kit cerniere + freno per sedile SLIM
SLIM soft close seat cover fixing kit system**Cod. KP + COD. SEDILE**Kit paracolpi
Spare bumpers set

309

**Cod. L1**Sistema universale a L per sanitari sospesi
Universal L-shaped fixing system wall-hung wc/bidet**Cod. C1**Raccordo per scarico pavimento
Elbow pipe for floor drain**Cod. C2**Curva tecnica per scarico traslato
Special elbow pipe for traslated outlet**Cod. C3**Curva tecnica per scarico arretrato
Special elbow pipe for backward outlet**Cod. E2**Raccordo eccentrico
Eccentric fitting**Cod. T1**Raccordo per scarico a parete
Pipe for wall drain**Cod. P1**Protezione e guarnizione antirumore
Acoustic and crash protection pad for sanitaryware

#NOTES

310

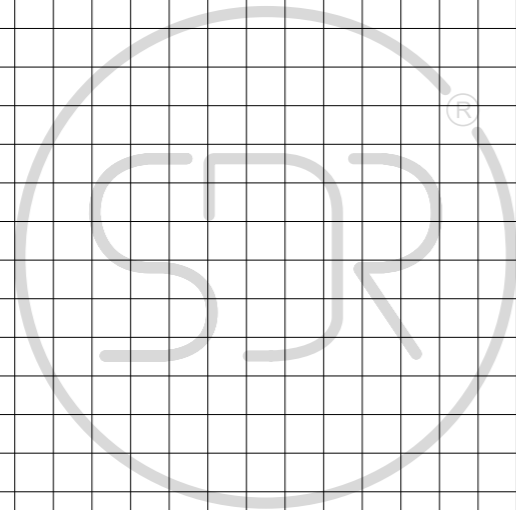

#NOTES

311

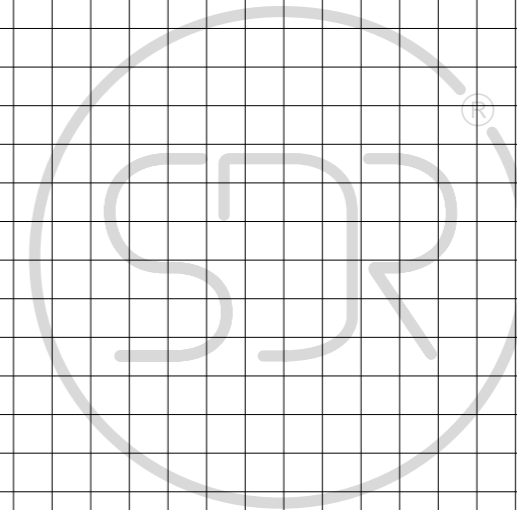



SDR CERAMICHE s.r.l.
Località Quartaccio snc
01034 Fabrica di Roma
(VT) Italy
T +39 0761 541055
F +39 0761 598449
info@sdrceramiche.it
export@sdrceramiche.it

credits

Art Direction
Studio21 srl

Texts
Studio21 srl

Images
Chromatika Multimedia

Printed by
Telligraf srl
Stampato in Italia
nel mese di maggio 2023

2023 - all rights reserved®

Il marchio ed il logo SDR sono marchi registrati. SDR Ceramiche SRL diffida l'utilizzo dei propri marchi, loghi, nomi di dominio e ragione sociale anche nei Paesi in cui non sono registrati; È vietato pertanto qualsiasi utilizzo senza il consenso della SDR Ceramiche SRL. Tutti i diritti qui non espressamente richiamati sono riservati. Tutte le immagini contenute nel presente catalogo sono di proprietà di SDR Ceramiche.

www.sdrceramiche.it

SDR brand and logo are trademarks. SDR Ceramiche SRL distrusts the use of its trademarks, logos, domain names and company names even in countries where they are not registered; it is strictly forbidden any use without the consent of SDR Ceramiche SRL. All rights are reserved. All the images are property of SDR Ceramiche SRL.

SCAN ME

